

Multifunction Products

Rampage!

AST
RESEARCH INC.

*Powerful Expanded
Memory Board for IBM®
PC, XT and Compatibles
Offering up to 2 Mb of
Paged Memory*

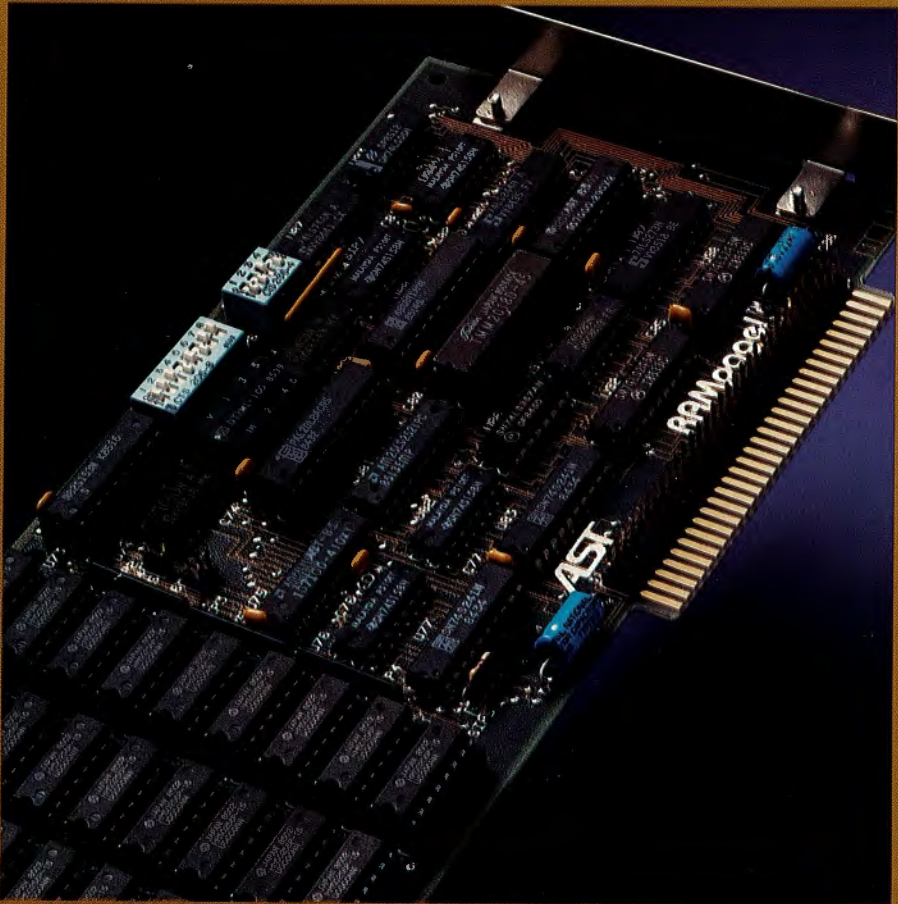

**THE AST
PREMIUM
SERIES**

User's Manual

Rampage[®]
Expanded Memory Card
for the
IBM[®] Personal Computer
IBM PC XT, and
IBM-Compatible Machines

User's Manual
000412-001 B
January 1987

AST RESEARCH[®], INC.
Irvine, California
(714) 863-1333

Fourth Edition (January 1987)

AST, AST Research, and Rampage are registered trademarks of AST Research, Inc. SixPakPremium, SuperPak, SuperDrive, SuperSpool, and fASTdisk are trademarks of AST Research, Inc.

IBM, AT, and PC-DOS are registered trademarks of International Business Machines Corporation. DESQview is a trademark of Quarterdeck Office Systems. Ashton-Tate and Framework II are trademarks of Ashton-Tate Corporation. Lotus, 1-2-3, and Symphony and are trademarks of Lotus Development Corporation.

AST Research periodically changes the information in this manual; changes are incorporated into new editions. AST Research reserves the right to modify this product's design.

In view of demonstrated product reliability and comprehensive warranty policies, AST Research, Inc. does not normally provide schematics or material lists. AST recognizes that some customers with a large installed base of AST products want supportive documentation for their own service organizations. In such cases, customers should contact AST Research corporate offices to consider an appropriate nondisclosure agreement to obtain this documentation.

A Product Comment Form is provided at the back of this publication. If this form has been removed, please address your comments to: AST Research, Inc., Attn: Product Marketing, 2121 Alton Avenue, Irvine, CA 92714. AST Research may use or distribute any of the information you supply in any way it deems appropriate without incurring any obligations whatsoever.

Copyright© 1985, 1986 AST Research, Inc. All rights are reserved, including those to reproduce this book or parts thereof in any form without permission in writing from AST Research, Inc.

WARNING

This manual and software are both protected by United States Copyright law (Title 17 United States Code). Unauthorized reproduction and/or sales may result in imprisonment of up to one year and fines of up to \$10,000 (17 USC 506). Copyright infringers may be subject to civil liability.

Rampage[®]
Expanded Memory Card
for the
IBM[®] Personal Computer
IBM PC XT, and
IBM-Compatible Machines

User's Manual
000412-001 B
January 1987

AST RESEARCH[®], INC.
Irvine, California
(714) 863-1333

Fourth Edition (January 1987)

AST, AST Research, and Rampage are registered trademarks of AST Research, Inc. SixPakPremium, SuperPak, SuperDrive, SuperSpool, and fASTdisk are trademarks of AST Research, Inc.

IBM, AT, and PC-DOS are registered trademarks of International Business Machines Corporation. DESQview is a trademark of Quarterdeck Office Systems. Ashton-Tate and Framework II are trademarks of Ashton-Tate Corporation. Lotus, 1-2-3, and Symphony and are trademarks of Lotus Development Corporation.

AST Research periodically changes the information in this manual; changes are incorporated into new editions. AST Research reserves the right to modify this product's design.

In view of demonstrated product reliability and comprehensive warranty policies, AST Research, Inc. does not normally provide schematics or material lists. AST recognizes that some customers with a large installed base of AST products want supportive documentation for their own service organizations. In such cases, customers should contact AST Research corporate offices to consider an appropriate nondisclosure agreement to obtain this documentation.

A Product Comment Form is provided at the back of this publication. If this form has been removed, please address your comments to: AST Research, Inc., Attn: Product Marketing, 2121 Alton Avenue, Irvine, CA 92714. AST Research may use or distribute any of the information you supply in any way it deems appropriate without incurring any obligations whatsoever.

Copyright© 1985, 1986 AST Research, Inc. All rights are reserved, including those to reproduce this book or parts thereof in any form without permission in writing from AST Research, Inc.

WARNING

This manual and software are both protected by United States Copyright law (Title 17 United States Code). Unauthorized reproduction and/or sales may result in imprisonment of up to one year and fines of up to \$10,000 (17 USC 506). Copyright infringers may be subject to civil liability.

CONTENTS

SECTION 1. INTRODUCTION	1-1
1.1 Hardware Features	1-2
1.2 Software Features	1-3
1.3 Example Memory Allocation	1-5
1.4 Getting Started	1-6
1.5 Checklist	1-8
1.6 System Requirements	1-8
1.7 How To Use This Manual	1-9
1.7.1 Format Notation	1-9
1.7.2 Related Documentation	1-9
1.7.3 Manual Outline	1-10
SECTION 2. CONFIGURING YOUR RAMPAGE BOARD ..	2-1
2.1 Default Configuration	2-1
2.2 Changing the Default Configuration	2-5
2.2.1 What You Need to Know Before You Start	2-5
2.2.2 Suggested Memory Configuration	2-7
2.2.3 RAM Configuration Settings	2-11
2.2.4 Base I/O Address Settings	2-12
2.2.5 Parity Checking Settings	2-13
SECTION 3. INSTALLING YOUR RAMPAGE BOARD	3-1
3.1 Preparing Your PC or PC XT	3-1
3.2 Installing Rampage in Your PC	3-6
SECTION 4. INSTALLING RAMPAGE SOFTWARE	4-1
4.1 Example SuperPak Configuration	4-2
4.2 Starting the INSTALL Program	4-3
4.3 Installing Options	4-8
4.4 Save the Installation	4-9

CONTENTS

APPENDIX A. SWITCH SETTING SUMMARY	A-1
A.1 Starting Memory Address	A-3
A.2 Rampage RAM Configuration	A-4
A.3 Parity Error Checking	A-6
A.4 Base I/O Address	A-6
A.5 Conventional Memory on Board	A-7
APPENDIX B. MEMORY ALLOCATION WITH DESQVIEW ..	B-1
B.1 Rampage Memory Allocation	B-1
B.2 PC and PC XT System Board Setting	B-2
APPENDIX C. ADVANCED INSTALL PROCEDURES	C-1
C.1 Using INSTALL	C-3
C.2 Running the INSTALL Program	C-5
C.3 Installing SuperPak Software for Another System	C-5
C.4 INSTALL Main Menu	C-8
C.5 Installing fASTdisk	C-10
C.6 Installing SuperDrive	C-12
C.7 Installing the AST Expanded Memory Manager .	C-14
C.8 Installing the Clock	C-15
C.9 Installing SuperSpool	C-16
C.10 Saving the Installation	C-19
APPENDIX D. ADDING OR REMOVING MEMORY	D-1
D.1 64-KB RAM Chip Specifications	D-1
D.2 256-KB RAM Chip Specifications	D-2
D.3 Rules for Adding or Removing Memory	D-4
D.4 Guidelines for Installing Chips	D-8

CONTENTS

APPENDIX E. HOW RAMPAGE WORKS	E-1
E.1 Memory Paging	E-1
E.2 Expanded Memory Manager — REMM.SYS	E-3
E.3 Extended Memory Emulator — REX.SYS	E-3
E.4 Modifying REMM and REX	E-4
E.4.1 DEVICE = REMM.SYS Parameters	E-4
E.4.2 DEVICE = REX.SYS Parameters	E-8
E.4.3 Modifying CONFIG.SYS for fASTdisk	E-9
APPENDIX F. TROUBLESHOOTING PROCEDURES	F-1
F.1 Error Messages	F-1
F.1.1 REMM Initialization Error Messages	F-1
F.1.2 REX Initialization Error Messages	F-3
F.2 Product Repair Procedure	F-4
GLOSSARY	G-1

Figures

Figure 1-1. Example Memory Map	1-6
Figure 2-1. Rampage Board Layout (Default Configuration)	2-4
Figure 2-2. Memory Configuration Switches	2-10
Figure 2-3. RAM Configuration Switch Settings	2-11
Figure 2-4. Base I/O Address Switch Settings	2-12
Figure 2-5. Parity Error Checking Settings	2-13
Figure 3-1. Removing the PC Cover	3-2
Figure 3-2. PC System Board Switch Settings	3-4
Figure 3-3. PC XT System Board Switch Settings	3-5
Figure 3-4. Installing the Plastic Card Guide	3-6
Figure 3-5. Installing the Rampage Board	3-7

CONTENTS

Figure 4-1.	Initial INSTALL Screen	4-5
Figure 4-2.	Main INSTALL Menu	4-7
Figure A-1.	Switches SW1 and SW2 on Rampage	A-2
Figure A-2.	Rampage Starting Address Settings	A-4
Figure A-3.	Rampage RAM Configuration	A-5
Figure A-4.	Parity Checking Switch Settings	A-6
Figure A-5.	Rampage Base I/O Address Settings	A-7
Figure A-6.	Conventional Memory Settings on the Rampage Board	A-8
Figure B-1.	Switch Settings for Best DESQview Performance	B-2
Figure C-1.	Main INSTALL Menu	C-9
Figure C-2.	INSTALL with FASTdisk Edit Box	C-11
Figure C-3.	INSTALL with SuperDrive Edit Box	C-13
Figure C-4.	INSTALL with SuperSpool Edit Box	C-18
Figure D-1.	Rampage Memory Banks (all Banks 256-KB)	D-5
Figure D-2.	Rampage Memory Banks (64-KB RAM in one Bank)	D-6
Figure D-3.	Rampage Memory Banks (64-KB RAM in 2 Banks)	D-7
Figure E-1.	Paging Technique	E-2

Tables

Table 2-1.	Rampage Default Configuration	2-2
Table 2-2.	Starting Addresses and Amounts of Conventional Memory on the Rampage Board	2-6
Table 2-3.	Suggested Rampage Memory Configurations	2-9
Table D-1.	Compatible 64-KB Memory Chips	D-2
Table D-2.	Compatible 256-KB Memory Chips	D-3

Rampage® is a flexible and powerful memory enhancement board, which represents a new generation of products to expand your PC's available memory. Rampage offers:

- *Conventional memory:* Any PC system memory from 0 to 640 kilobytes (KB) is called conventional memory.

Your PC system board contains a certain amount of conventional memory, and add-on boards (such as Rampage) can give your PC additional conventional memory. No matter how much memory you install in your computer, you can never have more than 640 KB of conventional memory. The IBM® PC Disk Operating System® (DOS) can directly use only the conventional (0 to 640 KB) memory in your PC.

- *Expanded memory:* (beyond the 640-KB limit). Many PC users needed more memory than 640 KB for use with application software packages. To solve this problem, software engineers developed a technique called *memory paging* to allow an IBM PC to use memory above 640 KB. Memory above 640 KB that is used by the memory paging technique is called *expanded memory*.

Special software, using the memory paging technique, is required to take advantage of expanded memory. Software designed for expanded memory must conform to the Expanded Memory Specification (EMS) or to the enhanced Expanded Memory Specification (EEMS).

Rampage expanded memory supports expanded memory specification (EMS) software, including

Lotus™ 1-2-3™ and Symphony 1.1™. These applications use expanded memory by interfacing with AST®'s expanded memory manager software, which is supplied with your Rampage board.

Rampage also supports the enhanced expanded memory specification (EEMS), providing superior performance with software written to support it, including the DESQview™ multitasking/windowing environment.

- *Emulated Extended Memory:* A PC or PC XT owner who wants memory beyond 640 KB must use expanded memory. However, some commonly available utility programs for creating random access memory (RAM) disks and print spoolers are designed for use with *extended memory*, memory in the 1-16 megabyte (MB) range on the PC AT. The Rampage Extended Memory Emulator (REX) software allows you to use your Rampage memory as emulated extended memory.
- *Full compatibility with the Lotus/Intel/Microsoft (LIM) version 3.2 Expanded Memory Specification.* In addition, AST's EEMS offers a more flexible paging scheme that maximizes software performance and exceeds the capabilities of the LIM EMS.

1.1 Hardware Features

Each Rampage board offers the following features:

- Up to 2 MB of expanded memory beyond the normal PC user memory limit of 640 KB. You can install as many as four Rampage boards in a single PC, thus increasing the available memory by 8 MB. A typical maximum configuration might be three Rampage boards (providing 6 MB of memory) and a SixPakPremium™ with a Premium-Pak installed (to provide 2 MB of memory plus I/O capabilities).

- Split Memory Addressing™, which allows Rampage to round out PC (or compatible) conventional memory to its 640-KB limit, then allocate remaining Rampage memory as expanded memory.
- Memory that is user-upgradeable in 256-KB or 64-KB increments. 64-KB or 256-KB RAM chips can be used for the first two memory banks, and 256-KB RAM chips can be used for the remaining six banks.

1.2 Software Features

- The Rampage Expanded Memory Manager (REMM) software driver, which works with EEMS software such as the DESQview operating environment to provide expanded memory for data and programs, and EMS application programs such as 1-2-3 Release 2 to provide expanded memory for data.

NOTE

To use Rampage expanded memory, the REMM.SYS program *must* be installed in the CONFIG.SYS file on your boot disk. The Superpak INSTALL program performs this installation automatically.

- The Rampage Extended Memory Emulator (REX) module, which works with REMM software to allow utilities (such as AST Research's fASTdisk™, SuperDrive™, SuperSpool™, and IBM's VDISK™ utility) to operate from expanded memory.
- AST's enhanced EMS (EEMS) exceeds the LIM EMS and is a superset of that standard. EEMS's more flexible paging scheme allows maximum software performance, including fast access to multiple programs and multitasking under DESQview .

NOTE

You can run several standard PC application programs — that together might require much more than 640 KB — at the same time under DESQview if your Rampage starting address is *256 KB or lower* (and your Rampage has enough memory installed). The more Rampage memory that is allocated in the area from 0 to 640 KB, the greater the enhancement of DESQview's performance. Appendix B tells you more about memory allocation with DESQview.

Rampage comes with these valuable SuperPak utility programs:

- *fASTdisk*: A program that simulates fixed disks in random access memory (RAM). A fASTdisk can be as large as total PC memory, and allows you to store and retrieve data and programs at RAM speeds.
- *SuperDrive*: A floppy disk emulation program that allows you to use part of your memory as a superfast "electronic disk drive".
- *SuperSpool*: An intelligent print spooler that allows you to output files to a printer while freeing your PC for other tasks.
- *ASTCLOCK™*: The real-time Clock/Calendar program that frees you from having to re-enter the time and date every time you boot your PC (for use with AST Clock/Calendar hardware).
- *INSTALL*: A software installation utility that allows easy installation of the fASTdisk, SuperDrive, SuperSpool, ASTCLOCK, and Rampage programs.

NOTE

You must use a version 6.20 (or later) SuperPak diskette with Rampage. For information on the SuperPak utilities, see your *SuperPak User's Manual*. All SuperPak software is fully downward-compatible, and can be used in place of any earlier SuperPak software you are now using with other AST products.

Your SuperPak diskette may also include other software (which may pertain to other AST products). The README file on your SuperPak diskette describes the programs included in your SuperPak software.

1.3 Example Memory Allocation

A typical example of how Rampage memory can be allocated is presented in this section. Suppose your PC has 256 KB of conventional memory installed and your Rampage provides 2 MB of RAM. You would like to use Rampage to accomplish the following:

- Fill out conventional memory to 640 KB.
- Use all remaining Rampage memory as expanded memory for use with application programs running under DESQview multitasking/windowing software. (This is the optional configuration for using DESQview and Rampage on an IBM PC.)

You would set Rampage for 256 KB of conventional memory already installed in your PC, and allocate 384 KB of Rampage memory to round out conventional memory to 640 KB. The remaining 1664 KB of Rampage memory would then be used as expanded memory. Note that this configuration requires a change to the Rampage factory default starting address of 640 KB. Figure 1-1 shows the memory map for this example application.

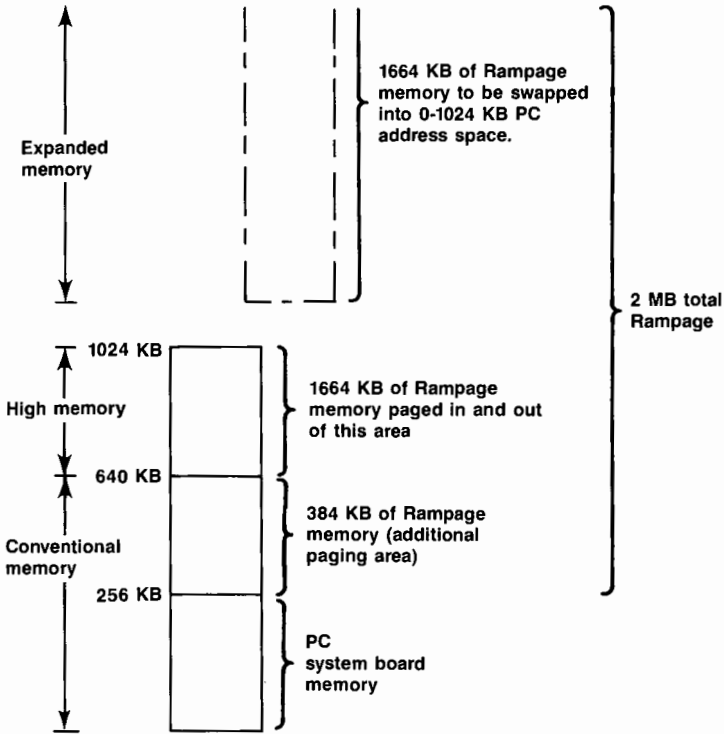

Figure 1-1. Example Memory Map.

1.4 Getting Started

This section tells you how to get Rampage started.

STEP 1

Check the contents of your Rampage package: Section 1.5 provides a checklist of what should be included with your package.

STEP 2

Review the system requirements for Rampage. Read Section 1.6 to make sure your system meets the requirements for using Rampage.

STEP 3

Decide on the configuration you need. How you configure Rampage depends on:

- How much memory is already installed in your PC. (How many KB's)
- Whether you will use DESQview (if so, see Appendix B).
- How much Rampage memory you want to allocate as *expanded memory*.
- Whether you have an AST SixPakPremium, or another Rampage board installed in your PC.

Section 2 provides further help in determining what Rampage configuration you need.

STEP 4

Configure Rampage: Based on the requirements you determined in STEP 3, set the switches on your Rampage board. You can use the configuration set at the factory (the *default configuration*) if:

- You already have exactly 640 KB of conventional memory in your PC.
- No other expanded memory board is installed in your system.

If the default configuration doesn't meet your needs, you must change the default configuration yourself. The Rampage has two switch blocks on it, SW1 and SW2. Each switch block has several switches on it that can be set to either ON or OFF. Section 2 fully describes how to configure SW1 and SW2.

STEP 5

Configure the PC/PC XT system board: If you will be using one or more SuperDrive RAM disks, you will need to set the PC or PC XT system board switches for the new number of diskette drives (so that the SuperDrive RAM disks are seen as diskette

Introduction

drives by your system). Section 3.1 describes how to set system board switches for the number of diskette drives and the amount of system memory present.

STEP 6

Install Rampage: Once the Rampage board is configured, you must install it in your PC. Follow the instructions in Section 3.

STEP 7

Install the software that comes with Rampage: Section 4 tells you how to use AST's INSTALL program to configure and install Rampage software.

STEP 8

Start your application software package. Choose EEMS- or EMS-compatible application software. See the instructions that came with your software.

1.5 Checklist

Before you get started, check that your Rampage package includes the following items:

- Rampage full-length expanded memory board.
- SuperPak diskette (version 6.20 or later).
- *Rampage-User's Manual* (000412-001).
- *SuperPak User's Manual* (000300-001).
- *DESeqview User's Manual* and DESeqview diskette.

1.6 System Requirements

The minimum hardware requirements for operation with Rampage are an IBM PC, PC XT or compatible with one floppy diskette drive and an unused full-length expansion slot.

Rampage software is compatible with DOS 2.0 or later or an MS-DOS equivalent.

1.7 How To Use This Manual

This section provides an outline of the format notation used throughout the manual, a list of related documentation, and an outline of the manual.

1.7.1 Format Notation

The following format notation is used in this manual:

- *Boldface* is used to indicate keyboard entries the user must make.
- *Uppercase characters* indicate items (such as commands) that you enter exactly as shown. However, you can enter those items in any combination of upper- or lowercase letters.
- *Lowercase letters* represent parameters that are defined by the user. While the user defines the parameters, they must satisfy the conditions of the command description.
- *Angle brackets (< >)* tell you to press a key. For example, <Esc> instructs you to press the "Esc" key. You do not have to press <Enter> unless you are specifically instructed to do so.
- *Square brackets ([])* indicate an optional term which is included or omitted at your discretion. The brackets are not entered.
- System prompts and messages are indicated in color.
- *Hexadecimal numbers* are indicated with a leading zero (0) and a trailing lowercase "h" (for example, 0208h).

1.7.2 Related Documentation

This manual assumes some familiarity with the PC-DOS operating system and the IBM PC hardware. You may find it useful to have available the following documents for reference:

- IBM PC *Guide to Operations*.

- *IBM PC Disk Operating System (DOS) Manual.*
- *SuperPak User's Manual (000300-001).*
- *Specification for an Expanded Memory Device Interface Product (Version 1.0), Copyright©1985 AST Research, 2121 Alton Avenue, Irvine, CA 92714.*
- *Enhanced Expanded Memory Specification (Enhanced EMS) Software Interface (Version 3.2), Copyright©1986 AST Research, 2121 Alton Avenue, Irvine, CA 92714.*
- *The Lotus®/Intel®/Microsoft® Expanded Memory Specification for Hardware Vendors (Version 3.2), Copyright ©1985 Lotus Development Corporation, 55 Cambridge Avenue Cambridge, MA 02142.*

1.7.3 Manual Outline

SECTION 1: INTRODUCTION

Describes the features of the Rampage product, and provides an overview on getting started, information on system requirements, format notation, and related documentation.

SECTION 2: CONFIGURING YOUR RAMPAGE BOARD

Provides a quick reference guide to the most common settings for Rampage and the PC system board. Includes a step-by-step guide through the switch settings.

SECTION 3: INSTALLING RAMPAGE IN YOUR PC

Tells you how to prepare your PC or PC XT and how to install Rampage in your PC or PC XT.

SECTION 4: INSTALLING SUPERPAK SOFTWARE

Gives a basic procedure for installing a typical software configuration on your boot disk that allows programs to use expanded memory.

APPENDIX A: SWITCH SETTING SUMMARY

A summary of all Rampage switch settings. Unless you have a particular reason to change the board configuration, you should not need the information in this appendix.

APPENDIX B: MEMORY ALLOCATION WITH DESQVIEW

Describes recommended PC, PC XT and Rampage switch settings for use with DESQview.

APPENDIX C: ADVANCED INSTALL PROCEDURES

Provides further details about using the INSTALL program to place SuperPak and expanded memory software on your boot disk. Describes how to modify the parameters for each program.

APPENDIX D: ADDING OR REMOVING MEMORY

Tells you how to add or remove Rampage memory. You don't need to read this section unless you are changing the amount of memory installed on Rampage.

APPENDIX E: HOW RAMPAGE WORKS

Gives a brief overview of how Rampage works, including the concept of memory paging, descriptions of the REMM and REX software modules, and how to modify them.

APPENDIX F: TROUBLESHOOTING PROCEDURE

Explains the error messages that your Rampage board can issue. Provides instructions for obtaining repair service on your AST Research product.

GLOSSARY

Provides definitions of several technical terms that appear in this manual.

NOTES

This section gives a step-by-step procedure for configuring the Rampage board. It provides the information you need to configure your board in most circumstances. Section 2.1 shows the Rampage default configuration (how the board is configured at the factory).

If you need to change any of the settings, Section 2.2 leads you step-by-step through each switch setting.

2.1 Default Configuration

This section provides a quick reference guide to the default settings for the Rampage board (shown in Figure 2-1).

If the default settings are appropriate for your system, *you can skip directly to Section 3 (Installing the Rampage Board)*. The default settings are appropriate if:

- You are installing Rampage in a PC or PC XT that already has exactly 640 KB of conventional memory installed.
- The starting address of Rampage memory is 640 KB. No Rampage memory will be used as system, or conventional memory.
- You install Rampage in its default configuration (summarized in Table 2-1).

If you are not sure whether you have 640 KB of conventional memory installed, or if you know you want to change any of the parameters shown in Table 2-1, see Section 2.2.

Table 2-1. Rampage Default Configuration.

Parameter	Default	Comments
I/O address	0218-0219h (SW2-1 OFF SW2-2 ON SW2-3 ON SW2-4 ON)	The I/O address setting tells your PC the address to use to communicate with the Rampage board. Do not change the default setting unless you are installing more than one Rampage board in your PC, or another device in your PC uses the same I/O address range.
Conventional Memory on Board	0 KB (SW2-5 OFF SW2-6 OFF SW2-7 OFF SW2-8 OFF)	This setting tells your PC how much Memory on Rampage memory to use as conventional memory. Since the default Rampage starting address is 640 KB, these settings are ignored in the default configuration, and all Rampage memory is used as expanded memory.
RAM Banks Configuration	Bank 0 is 64 KB. (SW1-5 ON SW1-6 OFF SW1-7 OFF)	This setting determines whether the first two banks are made up of 64-KB chips or 256-KB chips. The default configuration is 64 KB for the first bank and 256 KB for the remaining seven memory banks.
Parity checking	Enabled (SW1-8 ON)	Parity checking enables memory error checking. To ensure maximum data integrity, do not disable parity.
Starting memory address	640 KB (SW1-1 OFF SW1-2 ON SW1-3 OFF SW1-4 ON)	The starting memory address setting memory (together with the banks available setting) determines how much Rampage memory is to be used as conventional memory. If 640 KB is used, then all Rampage memory is used as expanded memory, none as conventional memory. You will need to change this parameter if you want to use some Rampage memory as conventional memory.

NOTE

You can run several standard PC application programs that together may require much more than 640 KB at the same time under DESQview if your Rampage starting address is 256 KB (and your Rampage has enough memory installed). The more Rampage memory allocated in the area from 0 to 640 KB, the greater the enhancement of DESQview's performance. Appendix B tells you how to configure your Rampage board for use with DESQview.

Configuring Your Rampage Board

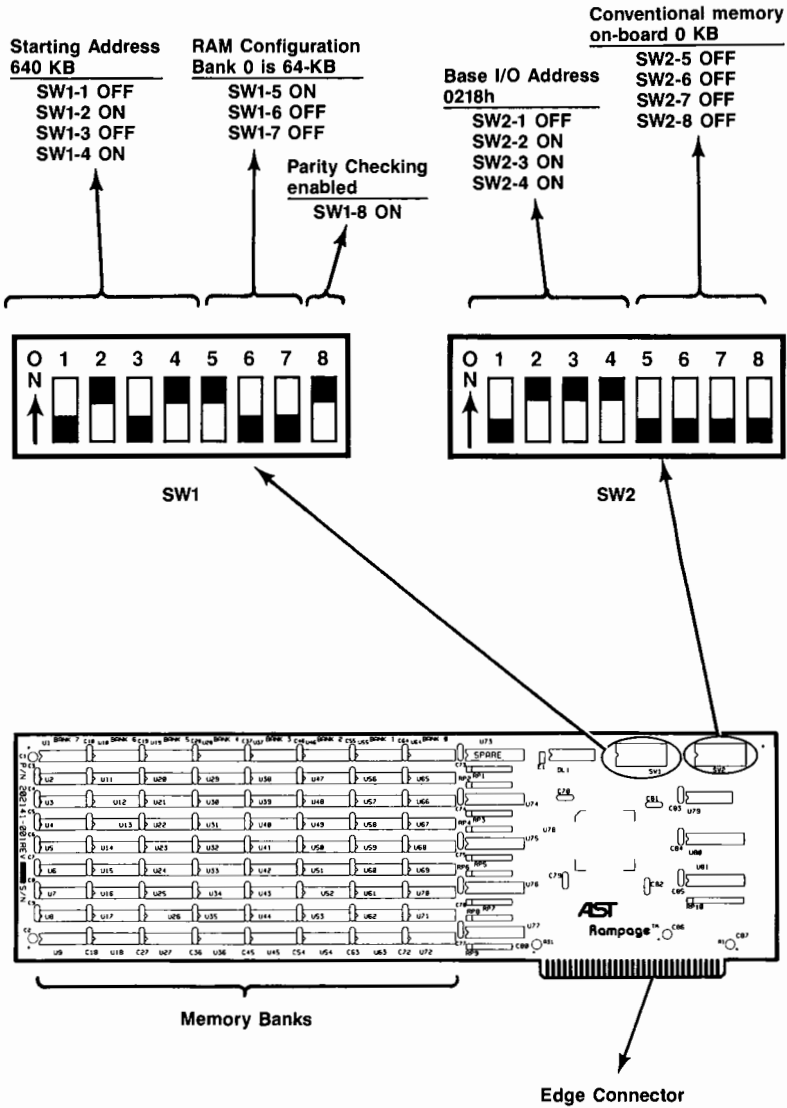

Figure 2-1. Rampage Board Layout (Default Configuration).

2.2 Changing the Default Configuration

This section tells you what you need to know before you change the configuration of your Rampage board, then guides you step-by-step through each switch setting on the board.

2.2.1 What You Need to Know Before You Start

Before you change the configuration of your Rampage board, you need to answer the following questions.

How much conventional memory is already installed in your PC?

PC system memory between 0 and 640 KB is called conventional memory. If you are unsure of how much system memory is installed in your computer, run the DOS CHKDSK command. Enter the following command at the DOS prompt from the diskette or disk drive that contains your DOS files (including the file CHKDSK.COM):

CHKDSK

DOS will return a report on the status of your default drive, including a line listing the total bytes of memory in your computer. An example follows of the status report you will get.

```
362496 bytes total disk space
 38912 bytes in 3 hidden files
279552 bytes in 42 user files

655360 bytes total memory
288544 bytes free
```

The amount given for “bytes total memory” is the only line you need to look at — this is the total memory in your computer. In the example above, the total memory is 640 KB (655360 bytes).

The amount of memory shown includes system board memory as well as any conventional memory (such as SixPakPlus memory) that has been added to your PC.

How much Rampage memory do you want to allocate as conventional memory?

If your PC has less than 640 KB of conventional memory installed, you may want to allocate Rampage memory to round out your system memory to 640 KB. This is accomplished through the Rampage conventional memory setting (SW2-5, SW2-6, SW2-7, and SW2-8), which determines how much Rampage memory will be used as conventional memory.

If you are using some Rampage memory as conventional memory, then you will also need to change your starting address setting (SW1-1 SW1-2, SW1-3, and SW1-4) to lower than the default of 640 KB. The starting address should equal your installed system memory, including any add-on card memory (such as memory on a SixPakPlus™ board). There should be no gap between already installed PC system memory and Rampage memory used as system memory.

The starting address and amount of conventional memory on your Rampage board should correspond, as shown in Table 2-2.

Table 2-2. Starting Addresses and Amounts of Conventional Memory on the Rampage Board.

Starting Address	Conventional Memory on Rampage Board
64 KB	576 KB
128 KB	512 KB
192 KB	448 KB
256 KB	384 KB
320 KB	320 KB
384 KB	256 KB
448 KB	192 KB
512 KB	128 KB
576 KB	64 KB
640 KB (default)	0 KB

Table 2-3 shows the Rampage switch settings for the memory configurations listed above.

How much Rampage memory do you want to allocate as expanded memory?

Generally, you will want to round out your system memory to 640 KB and use all remaining Rampage memory as expanded memory, setting the Rampage switches as shown in Table 2-3.

However, you *can* choose to use all Rampage memory as expanded memory even if you do *not* have a full 640 KB of system memory. If you wish to do this, you should set the starting address on your Rampage board to 640 KB.

Are there any other expanded memory boards installed in your PC?

If your PC includes any other expanded memory boards (for example, another Rampage board or AST's SixPakPremium board), you will need to make sure that Rampage and the other board(s) are configured to avoid conflicts with each other. Each expanded memory board must use a different base I/O address.

If you have more than one Rampage board installed in your system, you should set the starting address on your second Rampage board to 640 KB, so that all the memory on that board will be used as expanded memory. You can only have a starting address below 640 KB on one of your Rampage boards.

2.2.2 Suggested Memory Configurations

Table 2-3 provides a guide for configuring your Rampage memory to round out your PC system memory to 640 KB. You can also use this table if you have only enough Rampage memory to fill out part of the 640 KB of system memory.

Table 2-3 has a column for installed memory, a column for the Rampage switch settings for starting memory address, and a column for the Rampage switch settings for the amount of conventional memory on the Rampage board. The column

labeled "Installed Memory" refers to any memory you already have installed in your PC as system memory, including memory provided by add-on cards (such as a SixPakPlus).

The switch settings shown ensure that all your system memory will be contiguous (without gaps). The only time when Rampage memory does not have to be contiguous with PC system memory is when you choose to use *all* Rampage memory as expanded memory, regardless of the amount of PC system memory. In this case, use a Rampage starting address of 640 KB regardless of the amount of installed PC system memory you have.

CAUTION

To prevent memory conflicts, make sure that the Rampage starting address does not conflict with the memory used by any add-on memory installed in your PC. The starting address must be equal to either 640 KB or the total of your PC system board memory plus any installed add-on memory in your PC.

Table 2-3. Suggested Rampage Memory Configurations.

Installed Memory in PC	Rampage Starting Address	Starting Address Switch Settings (SW1-1,-2,-3,-4)	Rampage Conventional Memory	Conventional Memory Settings (SW2-5,-6,-7,-8)
64 KB	64 KB	(ON,OFF,OFF,OFF)	576 KB	(ON,ON,ON,OFF)
128 KB	128 KB	(OFF,ON,OFF,OFF)	512 KB	(OFF,OFF,OFF,ON)
192 KB	192 KB	(ON,ON,OFF,OFF)	448 KB	(ON,OFF,OFF,ON)
*256 KB	256 KB	(OFF,OFF,ON,OFF)	384 KB	(OFF,ON,OFF,ON)
320 KB	320 KB	(ON,OFF,ON,OFF)	320 KB	(ON,ON,OFF,ON)
384 KB	384 KB	(OFF,ON,ON,OFF)	256 KB	(OFF,OFF,ON,ON)
448 KB	448 KB	(ON,ON,ON,OFF)	192 KB	(ON,OFF,ON,ON)
512 KB	512 KB	(OFF,OFF,OFF,ON)	128 KB	(OFF,ON,ON,ON)
576 KB	576 KB	(ON,OFF,OFF,ON)	64 KB	(ON,ON,ON,ON)
640 KB	**640 KB	(OFF,ON,OFF,ON)	** 0 KB	(OFF,OFF,OFF,OFF)
<p>* Best setting for use with DESQview (see Appendix B).</p> <p>** Default setting. The switch settings for the amount of conventional memory on the Rampage board are ignored when the starting address is set to 640 KB, since all Rampage memory is then automatically allocated as expanded memory. The location of the memory configuration switch positions listed in Table 2-2 are shown in Figure 2-2.</p>				

The location of the memory configuration switch positions listed in Table 2-2 are shown in Figure 2-2.

Configuring Your Rampage Board

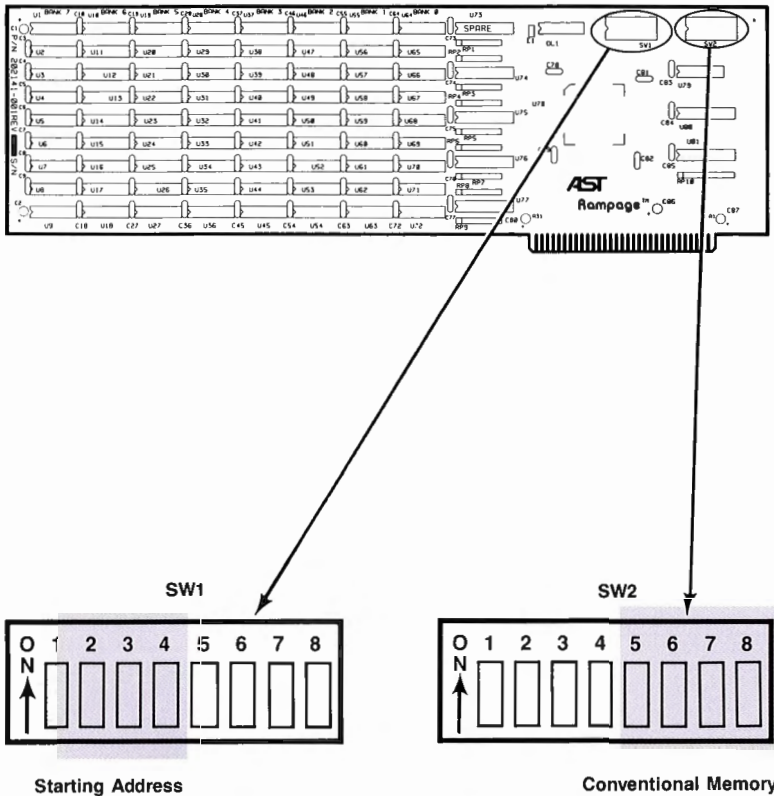

Figure 2-2. Memory Configuration Switches.

2.2.3 RAM Configuration Settings

Switch positions SW1-5, SW1-6, and SW1-7 set the RAM configuration for the first two banks on the Rampage board. These banks can be populated with either 64-KB RAM chips or 256-KB RAM chips. The factory switch settings assume that the first row of Rampage memory is populated with 64-KB RAM chips, and the remaining rows are populated with 256-KB RAM chips. You will only need to change this configuration in the following two situations:

- You have replaced the factory-supplied first row of 64-KB RAM chips with 256-KB RAM chips.
- The second row of your Rampage board is populated with 64-KB RAM chips.

CAUTION

If these switches are set incorrectly, you may not receive an error message, but you may lose portions of data when you are running an application software package. Correct setting of these switch positions is important for proper functioning of your Rampage board.

The switch settings and switch positions for RAM configuration are shown in Figure 2-3.

BANK 0	BANK 1	BANK 2	SW1-5	SW1-6	SW1-7
256 KB	256 KB	256 KB	OFF	OFF	OFF
** 64 KB	256 KB	256 KB	ON	OFF	OFF
64 KB	64 KB	256 KB	ON	ON	OFF
** Default setting.					

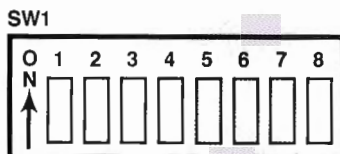

Figure 2-3. RAM Configuration Switch Settings.

2.2.4 Base I/O Address Settings

Your PC communicates with Rampage by means of a base I/O address. The Base I/O address is determined by switch positions SW2-1 through SW2-4. The default position for these switches sets the Rampage base I/O address to 0218h. Leave SW2-1 through SW2-4 in the default positions unless you have another expanded memory board in your computer, or another device that uses the base I/O address 0218h.

Two devices must never use the same I/O address. If you have another expanded memory board in your PC (such as another Rampage or a SixPakPremium), configure Rampage to use a different base I/O address. Figure 2-4 summarizes the possible base I/O addresses.

Base I/O Address	Rampage Switch Settings			
	SW2-1	SW2-2	SW2-3	SW2-4
0208h	ON	ON	ON	ON
*0218h	OFF	ON	ON	ON
0258h	OFF	ON	OFF	ON
0268h	ON	OFF	OFF	ON
02A8h	ON	OFF	ON	OFF
02B8h	OFF	OFF	ON	OFF
02E8h	ON	OFF	OFF	OFF
* Default setting				

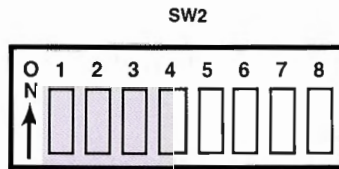

Figure 2-4. Base I/O Address Switch Settings.

2.2.5 Parity Checking Settings

Switch position SW1-8 enables or disables parity checking. By default, SW1-8 is ON, enabling parity checking. Leave SW1-8 ON unless you have a special reason to disable parity checking. Figure 2-5 shows the possible parity checking switch settings.

Parity Checking	SW1-8
* Enabled	ON
Disabled	OFF
* Default Setting.	

SW1

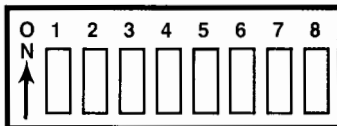

Figure 2-5. Parity Error Checking Settings.

NOTES

INSTALLING YOUR RAMPAGE BOARD **3**

This section provides installation instructions, including:

- Preparing your PC or PC XT for installing Rampage (Section 3.1).
- Installing Rampage in your computer (Section 3.2).

3.1 Preparing Your PC or PC XT

This section tells you how to prepare your PC or PC XT before installing Rampage.

Before installing your Rampage board, you must turn off your PC, disconnect any device attached to it, and remove the PC cover.

CAUTION

Be sure that the power switch is off and the power cord is unplugged from the wall outlet. Turn off any other equipment connected to the computer. Installing any component while the power is on can permanently damage your computer and its components.

You will need a flathead screwdriver or nut driver to perform the following procedure.

STEP 1

Remove the PC cover: Remove the cover mounting screws from your PC (see your PC's manual for the location of the cover mounting screws). Once you have removed the cover mounting screws, pull the PC cover off as shown in Figure 3-1.

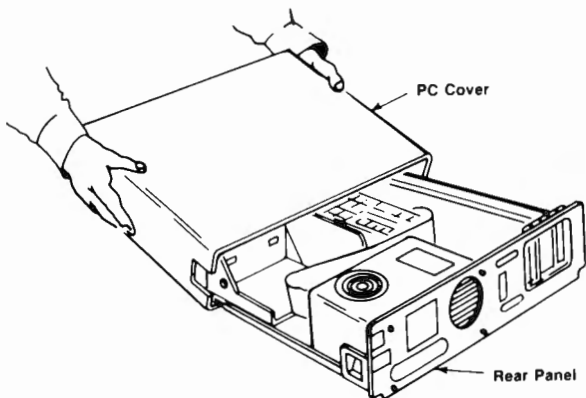

Figure 3-1. Removing the PC Cover.

STEP 2

Set PC or PC XT system board switches for the amount of system memory you have: Set the switches on your PC system board for the amount of memory installed in your PC, as shown in Figure 3-2 (for the PC) and Figure 3-3 (for the PC XT). For the PC (but not the PC XT), the amount of PC system board memory includes any Rampage and other add-on card memory you have allocated as PC system memory.

- *For the PC (not PC XT):* Set the PC system board for total system memory. You must tell the PC how much system memory is installed in your PC. The amount of system memory you set should include any Rampage memory you plan to allocate as system memory, as well as any other add-on card memory used as system memory (such as a SixPakPlus).

Add the amount of memory on the PC system board (including add-on card memory) and Rampage memory you have allocated as system memory. Set PC system board switch SW2 to the total (640 KB maximum) as shown in Figure 3-2. Remember that your IBM PC system board must be fully populated (filled to its maximum) before you can include

Rampage memory in the total system memory. (However, the system board does not need to be fully populated to use *expanded memory*.)

- *For PC XT's:* The system board switch in the PC XT tells the computer only how much memory is installed on the system board itself. Any expanded memory allocated from Rampage memory will automatically be recognized. The PC XT system board does not have to be fully populated to use extended or expanded memory. Verify that the system board switch is properly set as shown in Figure 3-3.

STEP 3

If you are installing SuperDrive: Your Rampage comes standard with the SuperDrive disk drive simulation program, which is described in Section 4. If you will be creating one or more SuperDrives, you must set the system board switch SW1 at this time for the total number of diskette drives, including SuperDrives, that will be in your system. The correct settings are shown in Figure 3-2 (for the PC) or Figure 3-3 (for the PC XT). The number of drives does *not* include any actual or simulated hard disk units (such as fASTdisk).

For further information on the SuperDrive program, see Section 4 in this manual, and see your *SuperPak User's Manual*.

IBM PC (64 KB and 256 KB system board)

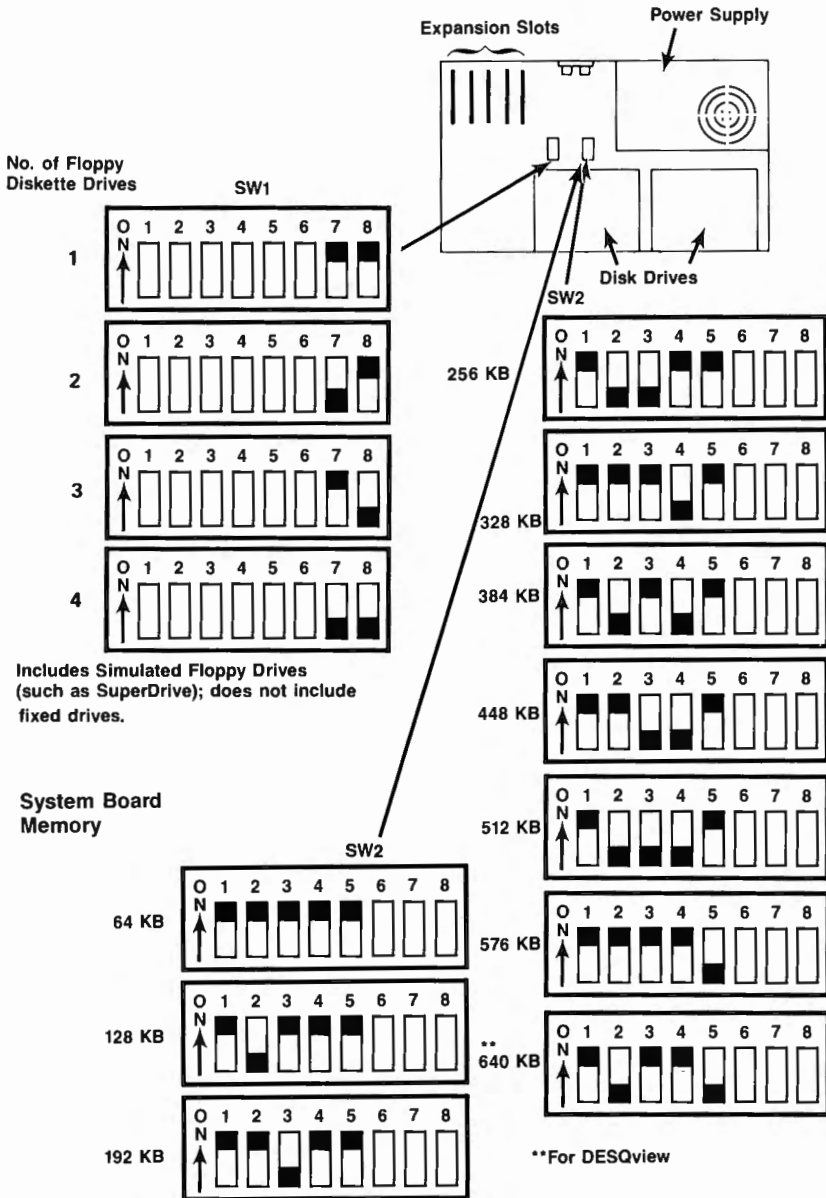
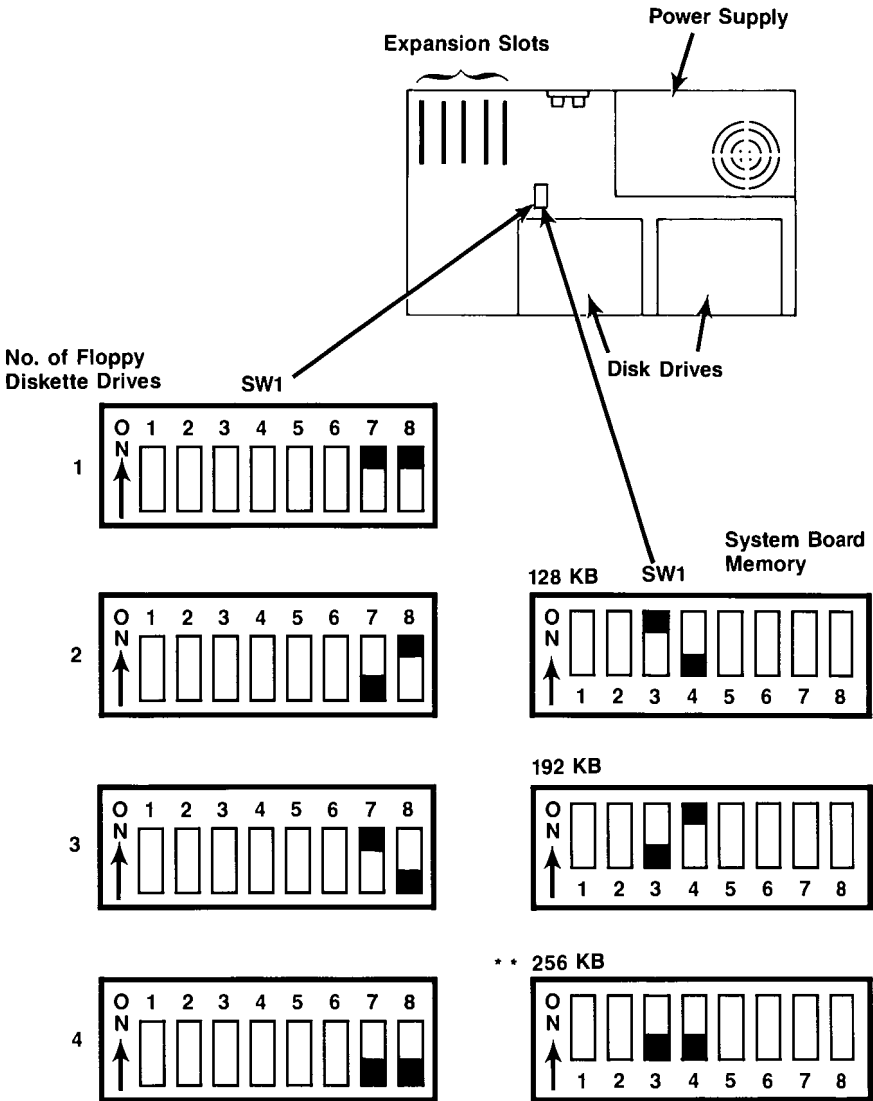

Figure 3-2. PC System Board Switch Settings.

IBM PC XT (also Portable PC and 3270 PC)



Includes Simulated Floppy Drives, such as SuperSpool
Does not include fixed disks. Does not include fASTdisk.

**For DESQview

Figure 3-3. PC XT System Board Switch Settings.

3.2 Installing Rampage in Your PC

STEP 1

Select an open expansion slot: The Rampage board requires one full-length slot.

STEP 2

Remove expansion slot cover: Locate the metal cover for the cut-out in the back panel of the PC chassis for the slot that you have selected. Remove and save the bracket retaining screw using a small flathead screwdriver. Remove the expansion slot cover.

STEP 3

Install the card guide: Install the plastic card guide supplied with the Rampage (if one is not already installed) on the inside of the front panel of the PC for the slot that will hold your Rampage board (Figure 3-4).

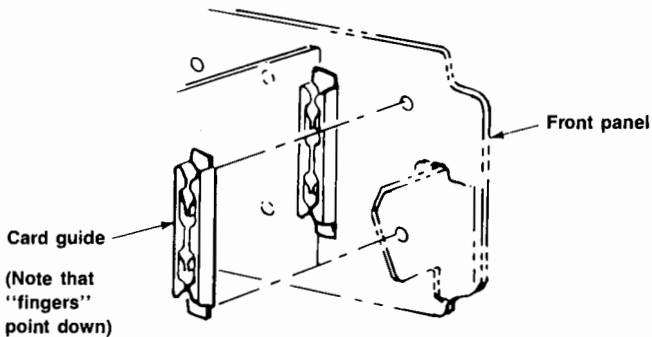

Figure 3-4. Installing the Plastic Card Guide.

STEP 4

Install the Rampage board: Line up your Rampage board and position its front bottom corner in the card guide channel. Position any wires or ribbon cables so they will pass either beneath or above the installed board and will not be damaged during installation. Lower the board until its edge connector is resting on the expansion slot receptacle. Using an evenly distributed pressure, press the Rampage board straight down until it is seated in the expansion slot (Figure 3-5).

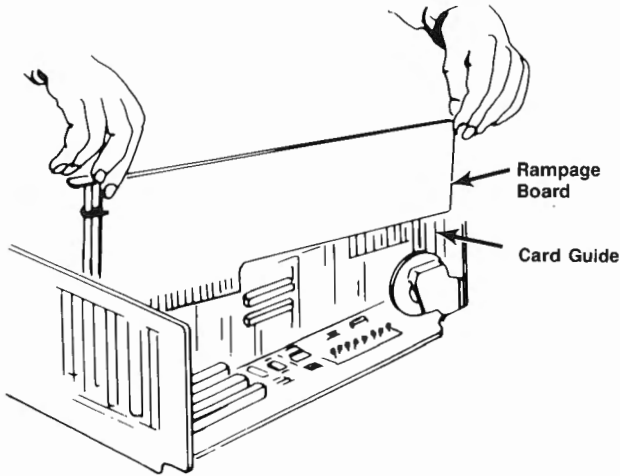

Figure 3-5. Installing the Rampage Board.

STEP 5

Secure the board to the rear of the PC chassis: Use the screw you removed from the expansion slot cover in STEP 2.

STEP 6

Replace the PC cover: Carefully slide the cover from the front until it stops securely against the rear panel. Reinstall the cover mounting screws you removed earlier.

Installing Your Rampage Board

STEP 7

Install cables: Replace the power cord to the system unit and be sure that the keyboard and the monitor connectors are plugged in. Reattach any other cables and connectors you removed previously.

STEP 8

Now you are ready to power up: Section 4 tells you how to install Rampage software.

This section introduces you to the menu-driven INSTALL program. INSTALL allows you to prepare a boot disk that takes advantage of Rampage's expanded memory and installs simple configurations of SuperPak programs. This section provides a step-by-step procedure for creating a simple SuperPak configuration using INSTALL. Detailed procedures for creating and modifying each SuperPak program are provided in Appendix C.

INSTALL places simple, basic configurations of the following SuperPak programs on your PC boot disk:

- *REMM.SYS*, the AST expanded memory manager that allows EMS and EEMS application programs to use your Rampage expanded memory. You must have *REMM.SYS* installed before your application programs can use Rampage expanded memory.
- *fASTdisk*, a RAM disk that emulates a fixed disk drive.
- *SuperDrive*, a RAM disk that emulates a floppy diskette drive.
- *SuperSpool*, a print spooling buffer that allows you to continue using your PC while your files print.
- *ASTCLOCK*, a Clock/Calendar program that keeps track of the time and date, even when your PC is off. To use this program, you need to have an AST board with Clock/Calendar hardware. INSTALL enables or disables use of the *ASTCLOCK* program. Full instructions for using the program are included in the manual for the hardware product that includes a Clock/Calendar.

NOTE

To run the INSTALL program, you must have either two floppy diskette drives, or one floppy diskette drive and a hard disk unit.

To install the programs listed above on your boot disk, the INSTALL program copies the needed SuperPak program files onto the boot disk and adds statements to the AUTOEXEC.BAT and CONFIG.SYS files on your boot disk. AUTOEXEC.BAT is a batch file that contains commands that are automatically executed when you boot up your PC. CONFIG.SYS contains the software drivers that allow devices that are external to your PC (such as REMM, REX and fASTdisk) to function.

If AUTOEXEC.BAT and CONFIG.SYS files do not already exist on your boot disk, INSTALL will create them for you. If those files do already exist on your boot disk, any existing statements not changed by the new installation will remain. INSTALL appends its statements to the end of existing AUTOEXEC.BAT and CONFIG.SYS files. If you run the INSTALL program more than once and specify the *same* configuration, the CONFIG.SYS and AUTOEXEC.BAT files will contain duplicate entries. You should delete the unwanted duplications using a text editor such as EDLIN.

4.1 Example SuperPak Configuration

Instructions follow for using INSTALL to create this typical SuperPak software configuration:

- Installation of the programs that allow EMS and EEMS applications to use expanded memory — REMM.SYS (AST expanded memory manager), and REX.SYS (which is automatically installed transparently to you when you install the AST expanded memory manager).
- One 512-kilobyte (KB) RAM disk that emulates a fixed disk drive (fASTdisk).

- One 360-KB RAM disk that emulates a floppy diskette drive (SuperDrive).
- One 64-KB RAM print spooling buffer, which frees your PC for other work while your files print (SuperSpool). It is assumed that you are sending output to a parallel printer port.

To install all the software listed above would require a minimum of 936 KB of memory available, not counting memory needed for an application program such as Framework. You can skip over creating a fASTdisk, SuperDrive, or SuperSpool, if you wish. However, you must install REMM.SYS in order to let your programs use Rampage expanded memory.

NOTE

Before you install fASTdisk, SuperDrive, or SuperSpool on your boot disk, be sure to remove any RAM disk or print spooler programs that you might already have on your boot disk.

The instructions given here should be adequate for most users, but if you want to customize your boot disk, see Appendix C. Also see Appendix C if you have any questions about the procedure described in this section.

4.2 Starting the INSTALL Program

To start the INSTALL program, follow these steps:

STEP 1

Back up the SuperPak diskette: Make a backup copy of the SuperPak diskette using the DOS COPY command. Store the master diskette in a safe place. You can then use the master diskette to back up your software if your working disk is lost or damaged.

If you are unsure about how to COPY a file, consult your DOS Manual.

STEP 2

Prepare a DOS system disk: You can either install SuperPak software on your existing DOS boot diskette or hard disk, or you can create a new boot disk.

To create a new boot diskette, format a blank diskette by entering the following DOS command from a disk or diskette drive where DOS files are present:

FORMAT n:/s <Enter>

where n: represents the diskette drive where the blank diskette resides.

If you want to boot from your hard disk, make sure the file COMMAND.COM is in your root directory.

STEP 3

Insert DOS system disk in drive B: or change to root directory for hard disk: If you want to boot from a floppy diskette, insert the DOS system disk you made in STEP 2 into drive B:. If you want to boot from the hard disk, make sure the root directory is the default.

STEP 4

Start the program: With the backup copy of your SuperPak diskette in the default drive, enter this command after the DOS prompt: **INSTALL <Enter>**

NOTE

To ensure proper operation, run INSTALL from DOS, not from another program such as DESQview.

The initial INSTALL screen shown in Figure 4-1 appears:

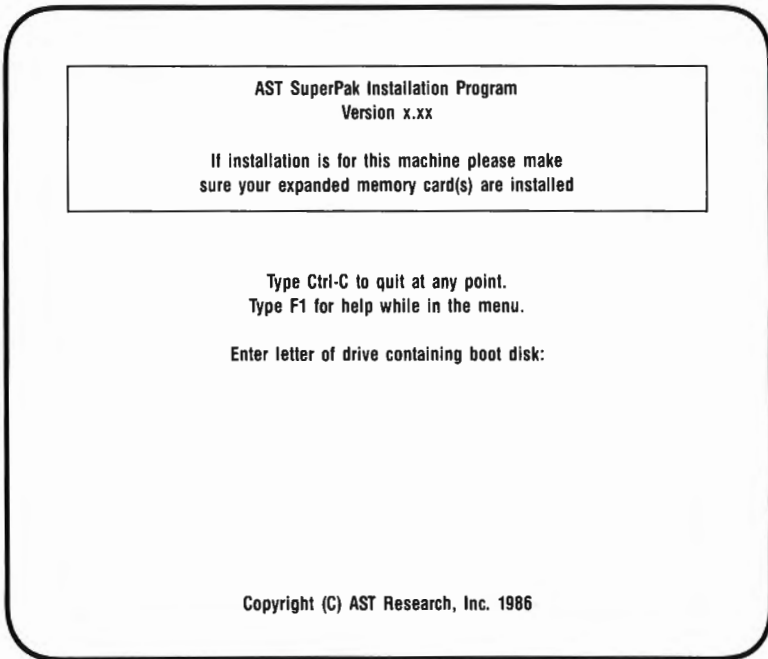

Figure 4-1. Initial INSTALL Screen.

STEP 5

Enter letter of drive containing boot disk: After the prompt, enter the letter of the drive containing the DOS system disk you created in STEP 2 (or the letter for your hard drive).

STEP 6

Identify the type of display adapter you are using:

The following question will then appear on your screen:

Is your video card one of the following (Y/N)?

- IBM Monochrome Adapter or compatible
- Hercules Graphics Adapter or compatible

If you press **N**, this line will appear:

- IBM Color Graphics Adapter or compatible

Installing Rampage Software

If you press **N**, this line will appear:

- IBM Enhanced Graphics Adapter or compatible

Press **Y** for the type of video card installed in your PC. Press **N** if your PC does not have one of those video cards installed. This question allows INSTALL to avoid conflicts with the memory area used by your video card.

If you are using INSTALL to configure a boot disk for a PC other than the one you are using now, identify the type of display adapter for *that* machine.

Your screen will then display this question:

Is installation for this machine (Y/N)?

Press **Y**.

If you are installing for another machine, press **N** and proceed to Appendix C, Section C.3.

When you press Y, this message is displayed on the screen:

Testing for expanded memory boards...

Next, the main menu shown in Figure 4-2 appears.

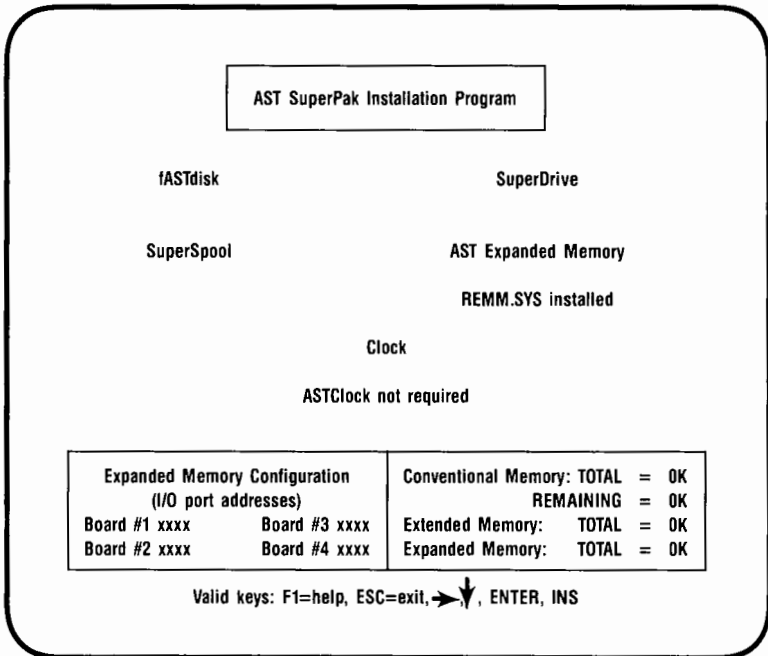

Figure 4-2. Main INSTALL Menu.

Notice that the amounts of conventional and expanded memory you selected with the Rampage hardware switches SW1 and SW2 automatically appear at the bottom of the screen. For conventional memory, both the total amount and the remaining amount that has not been allocated are shown.

The amount of extended memory shown refers to expanded memory that *emulates* extended memory. As you progress, you will notice that as extended memory is allocated, it may be subtracted from expanded memory. This indicates that extended memory is "borrowing" from expanded memory (that is, expanded memory is emulating extended memory).

4.3 Installing Options

A step-by-step procedure follows for installing the sample configuration described above (one fASTdisk, one SuperDrive, one SuperSpool, and expanded memory manager software). The option of skipping over creating a fASTdisk, SuperDrive, or SuperSpool is included in the procedures that are provided.

STEP 1

Install fASTdisk: (If you do not wish to install a 512-KB fASTdisk, go directly to Step 2.) When the main INSTALL menu appears, the fASTdisk option is highlighted. To install one 512-KB fASTdisk (the default memory size), press <Enter> once. The screen changes to indicate you have installed one fASTdisk in its default configuration.

NOTE

If you accidentally press <Enter> more than once, you will install a second fASTdisk. To delete the second fASTdisk, press the down-arrow to highlight the second fASTdisk listing and press .

STEP 2

Install SuperDrive: (If you do not wish to create a SuperSpool, go to STEP 3). To install a 360-KB SuperDrive, press the right-arrow to highlight the SuperDrive option. Press <Enter> once. A line will appear describing the SuperDrive you have created. It lists the memory size of the SuperDrive (which should be 360 KB) and the letter designation of the SuperDrive.

The letter designation for the SuperDrive you have created should be the next unused letter after your existing diskette and disk drives. For example, if you have two floppy drives, A and B, then your SuperDrive should be designated as C. If you have two floppy drives (A and B) and a hard drive C, then your SuperDrive should be designated as D. If the letter provided by INSTALL is not appropriate for your configuration, then you will have to "edit" the SuperDrive you have created.

To edit your SuperDrive, highlight the SuperDrive you have created, then press <Enter> to invoke the INSTALL edit box. Select the device letter parameter in the edit box by pressing the down arrow key. Then press the right- or left-arrow key to select the device letter you wish to use. Once the correct letter appears, press <Esc> to exit the edit box, leaving your SuperDrive with the new device letter you have selected.

STEP 3

Install SuperSpool: (If you do not wish to create a SuperSpool buffer for a parallel printer, go to STEP 4). To create a 64-KB SuperSpool buffer, press the right-arrow to highlight the SuperSpool option. Press <Enter> once.

STEP 4

Install Expanded Memory Manager: As long as the message "REMM.SYS installed" appears on the main menu, the REMM.SYS software that allows applications to use expanded memory is installed automatically when you save the installation. Another program, REX.SYS, will be installed automatically if needed. If the message "REMM.SYS not installed" appears, you can change it to "REMM.SYS installed" by pressing the right-arrow key to highlight "AST Expanded Memory", then pressing <Enter>.

4.4 Save the Installation

To save the installation on your boot disk, follow the procedure below.

STEP 1

Save the configuration: Exit the Install program by pressing <Esc>. This question appears at the bottom of your screen:

Do you want to quit (y/n)?

Press **Y**. You will see this question:

Do you want to save configuration (y/n)?

Installing Rampage Software

Press **Y**. These messages appear at the bottom of the screen:

Writing CONFIG.SYS to x:...

Writing AUTOEXEC.BAT to x:...

where x: is the drive containing the boot disk.

STEP 2

Copy utility files to boot disk: The screen clears, then shows this message:

For the configuration process to be complete, the following SuperPak utility files need to be present on your boot disk:

The above message is followed by a list of files necessary to install your SuperPak software, and this question is displayed:

Do you want these files copied to your boot disk (Y/N)?:

Press **Y**.

Place your SuperPak diskette in drive A: if it is not already there. The following message will appear:

Enter the letter of the disk drive containing your SuperPak software:

Enter **A**.

This concludes the procedure for creating a sample SuperPak boot disk. You will now want to copy your application software (such as DESQview) to the disk. You must reboot the system with your new boot diskette before you can use Rampage expanded memory (and any fASTdisk, SuperDrive RAM disks, or SuperSpool print spooler you have created). If you have added a SuperDrive RAM disk, you must be sure that your PC system board switch is set for the total number of diskette drives you have, including the new SuperDrive you have created. (See Section 3.1 for instructions on setting the system board switch.)

SWITCH SETTING SUMMARY

A

This appendix provides a quick reference to the different SW1 and SW2 Dual Inline Process (DIP) switch configurations you can set on your Rampage board. The default configuration of the Rampage board is described in detail in Section 2.1.

- Section A.1 summarizes all the possible *starting memory address* SW1 switch settings.
- Section A.2 summarizes all the possible *Rampage board RAM configuration* SW1 switch settings.
- Section A.3 tells you how to set the SW1 switch to enable or disable *parity error checking*.
- Section A.4 summarizes all the possible *base I/O address* SW2 switch settings.
- Section A.5 summarizes all the possible *conventional memory on board* SW2 switch settings.

Figure A-1 shows the locations of switches SW1 and SW2 on the RAMpage board.

Rampage Switch Settings

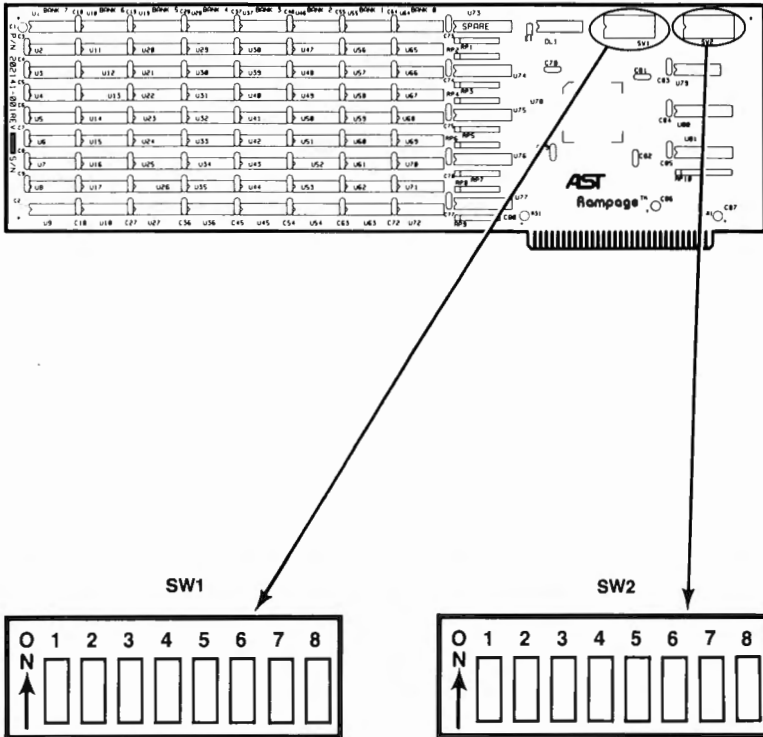

Figure A-1. Switches SW1 and SW2 on the Rampage Board.

A.1 Starting Memory Address

Switch positions SW1-1 through SW1-4 define the Rampage starting address, as shown in Figure A-2. This setting tells Rampage software how much system memory is installed in your PC before adding a Rampage board.

CAUTION

To prevent memory conflicts, make sure that the Rampage starting address does not conflict with any add-on memory installed in your PC.

In general, the starting address must be equal to the total of your PC system board memory plus any installed add-on memory in your PC. The one exception to this is if you are planning to use all your Rampage memory as expanded memory without rounding out your system memory to 640 KB. In this situation, you would set your starting address to 640 KB.

All switch settings other than those shown below are reserved.

Starting Address	SW1-1	SW1-2	SW1-3	SW1-4
64 KB	ON	OFF	OFF	OFF
128 KB	OFF	ON	OFF	OFF
192 KB	ON	ON	OFF	OFF
* 256 KB	OFF	OFF	ON	OFF
320 KB	ON	OFF	ON	OFF
384 KB	OFF	ON	ON	OFF
448 KB	ON	ON	ON	OFF
512 KB	OFF	OFF	OFF	ON
576 KB	ON	OFF	OFF	ON
** 640 KB	OFF	ON	OFF	ON
*Best setting for use with DESQview (see Appendix B).				
**Default setting.				

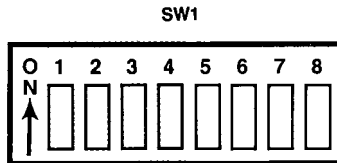

Figure A-2. Rampage Starting Address Settings.

A.2 Rampage RAM Configuration

Switch positions SW1-5 to SW1-7 tell your system what type of RAM memory chips are used in the first two rows of memory on the Rampage board. The first two banks of memory can be filled with either 64-KB RAM chips or 256-KB RAM chips. The switch settings should correctly reflect your Rampage configuration.

CAUTION

If these switches are set incorrectly, you may not receive an error message, but you may lose portions of data when you are running an application software package. Correct setting of these switch positions is important for proper functioning of your Rampage board.

Figure A-3 shows the possible switch settings for Rampage RAM configuration.

Bank 0	Bank 1	Bank 2	SW1-5	SW1-6	SW1-7
256K	256K	256K	OFF	OFF	OFF
**64K	256K	256K	ON	OFF	OFF
64K	64K	256K	ON	ON	OFF
** Default setting.					

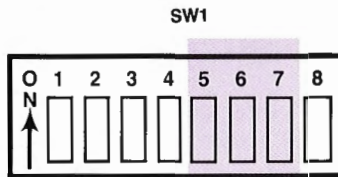

Figure A-3. Rampage RAM Configuration.

A.3 Parity Error Checking

Switch position SW1-8 enables or disables the parity error checking, as shown in Figure A-4.

Parity Checking	SW1-8
*Enabled	ON
Disabled	OFF
*Default Setting.	

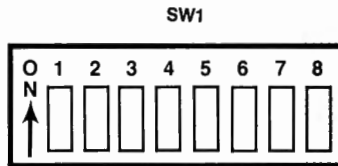

Figure A-4. Parity Checking Switch Settings.

A.4 Base I/O Address

Switch positions SW2-1 through SW2-4 define the EMS-compatible base I/O address used for communication between your Rampage board and your PC. If you have another expanded memory board in your PC (such as another Rampage board) each board must use a different base I/O address. Figure A-5 shows the switch settings and corresponding values for the Rampage base I/O address.

Hexadecimal Base I/O Address	Rampage Switch Settings			
	SW2-1	SW2-2	SW2-3	SW2-4
0208h	ON	ON	ON	ON
*0218h	OFF	ON	ON	ON
0258h	OFF	ON	OFF	ON
0268h	ON	OFF	OFF	ON
02A8h	ON	OFF	ON	OFF
02B8h	OFF	OFF	ON	OFF
02E8h	ON	OFF	OFF	OFF
* Default Setting.				

SW2

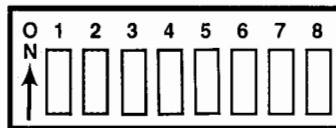

Figure A-5. Rampage Base I/O Address Settings.

A.5 Conventional Memory on Board

Switch positions SW2-5 through SW2-8 define how much Rampage memory (if any) is available for allocation as system memory (0 to 640 KB), as shown in Figure A-6.

If the starting address for the Rampage board is set to 640 KB (the factory default setting), then all Rampage memory will be used as expanded memory regardless of the conventional memory switch settings.

Conventional Memory on the Rampage Board	Rampage Switch Settings			
	SW2-5	SW2-6	SW2-7	SW2-8
* 0 KB	OFF	OFF	OFF	OFF
64 KB	ON	ON	ON	ON
28 KB	OFF	ON	ON	ON
192 KB	ON	OFF	ON	ON
256 KB	OFF	OFF	ON	ON
320 KB	ON	ON	OFF	ON
** 384 KB	OFF	ON	OFF	ON
448 KB	ON	OFF	OFF	ON
512 KB	OFF	OFF	OFF	ON
576 KB	ON	ON	ON	OFF

*Default setting.
 **Best allocation for DESQview users. See Appendix B.

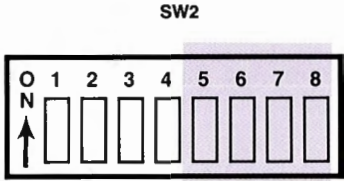

Figure A-6. Conventional Memory Settings on the Rampage Board.

This appendix tells you how to enhance the performance of the DESQview program that comes with Rampage. If you plan to use DESQview, you will want to allocate system memory and Rampage memory to maximize DESQview's performance. (The *DESQview User's Manual* provides additional detailed information.)

B.1 Rampage Memory Allocation

For optimum performance with DESQview, *allocate as much Rampage memory as conventional memory (memory in the 0- to 640-KB range) as possible.*

DESQview takes advantage of the enhanced expanded memory specification (EEMS) — it can swap application programs very rapidly into Rampage memory in the 0- to 640-KB range used by the IBM PC Disk Operating System (DOS). This allows concurrent execution of programs that together use more than 640 KB of memory.

To achieve the best possible DESQview performance, you should use a *minimum* of 384 KB of Rampage memory as PC system memory, or conventional memory. For this allocation, you should set your Rampage starting memory address to 256 KB, and your Rampage conventional on-board memory to 384 KB, as shown in Figure B-1.

This assumes that you already have at least 256 KB of system memory installed in your PC. If you have less than 256 KB of system board memory, you can use Figure A-2 to set your starting memory address even lower than 256 KB, allowing you to run even larger sized programs under DESQview. If you have more than 256 KB of conventional memory installed in your PC, you may choose to remove or disable any

conventional memory beyond 256 KB. This would allow you to use Rampage memory to fill in between 256 KB and 640 KB, enhancing DESQview performance.

B.2 PC and PC XT System Board Setting

To recognize 256 KB of system memory, your system board SW1 switch setting for the PC or PC XT should be set as shown in Figure B-1.

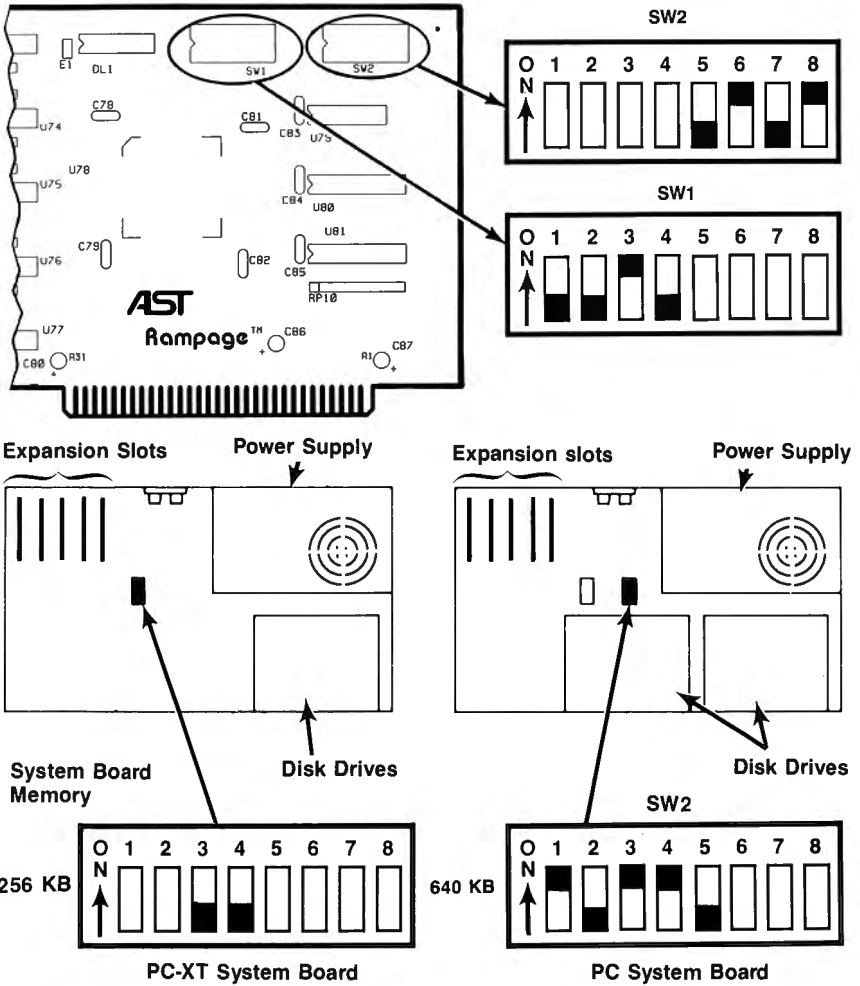

Figure B-1. Switch Settings for Best DESQview Performance.

Section 4 introduced you to the INSTALL program and explained how to use it to install a simple configuration of SuperPak programs on your boot disk. This section provides more advanced information on how to use the INSTALL program, including step-by-step details on how to modify the default operating parameters for each SuperPak program. It is assumed that you have already read Section 4 before reading this section.

You can use the INSTALL program to install the following programs on your PC AT boot disk:

- *fASTdisk*, the program that simulates up to two fixed disk drives in RAM. You can change the size and memory type for each fASTdisk.
- *SuperDrive*, the program that simulates 360-KB floppy disk drives in RAM (default size 360 KB). INSTALL can install up to two SuperDrives in your system. You can change the letter designation and memory type for each SuperDrive.
- *SuperSpool*, the program that creates a RAM print spooling buffer (default size 64 KB), freeing your PC for other work while your files print. You can change the device name, size, and memory type for the SuperSpool buffer.
- *AST Expanded Memory*, the software that enables expanded memory, providing maximum performance with new multitasking/windowing software. This software allows you to use expanded memory specification (EMS) programs. You can enable or disable this feature. The expanded memory manager is automatically installed when expanded memory is used to create RAM disks or a print spooler.

- **ASTCLOCK**, the Clock/Calendar program that keeps track of the time and date, even when your PC is off. You will only need to use this program if you have a Clock/Calendar installed in your PC, on another AST board.

(Once you have installed the clock software, you must still set the correct time and date after rebooting your PC, as described in the Clock/Calendar section of the AST product that has a Clock/Calendar.)

NOTE

All SuperPak files may not pertain to your particular AST product. Your SuperPak diskette contains a README file that describes which files are applicable to your product. To display this file, enter the following command at the DOS prompt for the drive containing your SuperPak diskette:

README <Enter>

For more information on SuperPak software, see your *SuperPak User's Manual*. For more information on AST expanded memory software, see Appendix E of this manual.

You will have to modify your AUTOEXEC.BAT and/or CONFIG.SYS files (using a text editor) after running INSTALL if you want to send printer output to a serial (not parallel) port, or if you want to use advanced parameters for the SuperPak software. The *SuperPak User's Manual* discusses the SuperPak utilities in greater detail.

C.1 Using INSTALL

For your convenience, INSTALL uses a screen and keyboard interface design similar to popular spreadsheet programs:

The main SuperPak INSTALL menu offers several options (including SuperDrive, SuperSpool, and fASTdisk). To install an option on your boot disk (such as a SuperDrive), you must first select that option by highlighting it, then create the highlighted option by pressing the <Enter> or <Ins> key. When you exit the INSTALL program, all the options you have created are saved on your boot disk.

- The currently selected option is highlighted in reverse video. To move from one option to another, press the right- or left-arrow keys on the numeric keypad to the right of your keyboard.
- Once you have selected (highlighted) an option, you create that option by pressing the <Enter> or <Ins> key.
- Press <F1> to bring up a help screen that corresponds to the currently highlighted option.
- Press <Ctrl>-C to abort the INSTALL program without changing your AUTOEXEC.BAT or CONFIG.SYS files.

If you want to modify the default parameters (such as memory size) for an option you have created, then you need to call up the INSTALL edit box after you have created the option. This is applicable only to the fASTdisk, SuperDrive, and SuperSpool options.

- To call up the INSTALL edit box, highlight the created option you want to modify (for example, one of two fASTdisks you may have created). After this, press <Enter> to invoke the edit box.

- The edit box presents the parameters you can change for the created option you are editing. Select the parameter you want to change by pressing the up- or down-arrow key. If the parameter requires a numeric value, you can enter a new value. If the parameter is for a memory type, device letter or device name, you can press the right- or left-arrow key to select from the available parameters.
- To exit the edit box once you have set the parameters as you want them, press **<Esc>**.
- The cursor appears as an underline character when an alphanumeric entry is required from you.

If you want to delete an option, highlight the option you wish to delete (such as SuperDrive). Then press the up- or down-arrow key to select (highlight) the particular created option you want to delete. Next press the **** key to delete the highlighted created option.

Once you have installed and configured your SuperPak options, you can choose to save the installation you have created. When this is done, INSTALL modifies the AUTOEXEC.BAT and CONFIG.SYS files on your boot disk. If those files do not already exist on your boot disk, INSTALL will create them for you. If those files do already exist on your boot disk, any existing statements not changed by the new installation will remain. INSTALL appends its statements to the end of existing AUTOEXEC.BAT and CONFIG.SYS files.

AUTOEXEC.BAT is a batch file that contains commands that are automatically executed when you boot up your PC. The CONFIG.SYS file installs the software drivers that allow devices that are external to your PC (such as REMM, REX and fASTdisk) to function.

INSTALL first creates fASTdisks, SuperDrives, and the SuperSpool from expanded memory that is emulating extended memory, then uses conventional memory if available expanded memory is exhausted. If you create a device that is

larger than available expanded memory, this message is displayed at the bottom of the screen:

Not enough extended memory — switching to conventional

NOTE

The term “extended memory” in the INSTALL program refers to Rampage empaned memory that *emulates* extended memory (such as the PC AT provides) via the REX.SYS program. REX allows you to set up RAM disks and print spoolers outside of the 0- to 640-KB area.

Each device can be composed of only one memory type (extended *or* conventional). INSTALL allocates available expanded memory as extended memory only as necessary to create the device.

C.2 Running the INSTALL Program

Go to Section 4.2 for full instructions on how to start the INSTALL program running.

C.3 Installing SuperPak Software for Another System

After you have started running the INSTALL program (as described in Section 4.2), you will be presented with the following question —

Is installation for this machine (y/n)?:

press **N** if you are installing SuperPak software for another PC. This causes INSTALL to display these questions about the PC for which you are installing software:

Is your computer a PC AT or AT-compatible (Y/N)?

Enter amount of conventional memory in K bytes:

Enter amount of extended memory in K bytes:

Enter amount of expanded memory in K bytes:

Enter number of floppies and RAM diskettes (1-4):

(These amounts are automatically determined by the INSTALL program if you answered "Y".

Is your computer a PC AT or AT-compatible (Y/N)?: Press **Y** if you are installing software for a PC-AT or compatible. Press **N** if you are installing software for a PC that is not a PC AT.

Enter amount of conventional memory in kilobytes. Enter the number of kilobytes (from **0** to **640**) of conventional memory for the computer whose software you are installing (including any memory allocated from Rampage AT). Conventional memory (as opposed to expanded or extended memory) is the PC AT system memory between 0 and 640 KB. Pressing **<Enter>** is equivalent to entering "0".

Enter amount of extended memory in kilobytes. Enter the number of kilobytes (from **0** to **1536**) of actual, physical extended memory for the PC AT whose software you are installing. Extended memory (*not* expanded memory) is the non-paged memory in the 1 to 16 megabyte range. Pressing **<Enter>** is equivalent to entering "0".

Enter amount of expanded memory in kilobytes. Enter the number of kilobytes (from **0** to **8192** — 8 megabytes of expanded memory) for the computer whose software you are installing. The amount of expanded memory is the total amount of memory on your AST expanded memory product that is *not* allocated as conventional or extended memory.

For example, if you have a 2-MB AST board and you have allocated 384 KB of the board's memory as conventional memory, enter "1664" (2048 minus 384) for the amount of expanded memory.

Expanded memory (as opposed to conventional or extended memory) is also known as "paged memory", and is available for paging or extended memory emulation. Pressing <Enter> is equivalent to entering "0".

EXAMPLES

Here are some examples of how you would supply the requested memory amounts for several different configurations:

- Your PC AT has 256 KB of system memory and a 2-MB Rampage AT board. You have allocated 384 KB as conventional memory and 512 KB as extended memory. Enter these parameters:

Conventional memory: **640**

Extended memory: **512**

Expanded memory: **1152** — (2048 minus 512 minus 384)

- Your PC AT has 512 KB of system memory and a 2-MB Rampage AT board. You have allocated 128 KB as conventional memory and all remaining Rampage AT memory as expanded memory. Enter these parameters:

Conventional memory: **640**

Extended memory: **0**

Expanded memory: **1920** — (2048 minus 128)

- Your PC AT has 256 KB of system memory, a 2-MB Rampage AT, and a 1.5-MB *Advantage!* board. You have allocated all *Advantage!* memory as extended memory, 384 KB of Rampage AT memory as conventional memory, and all remaining Rampage AT memory as expanded memory. Enter these parameters:

Conventional memory: **640**

Extended memory: **1536**

Expanded memory: **1664** — (2048 minus 384)

Enter number of floppies and RAM diskettes (1-4): Enter the number (from **1** to **4**) of floppy diskettes (including random access memory (RAM) floppy diskettes, such as SuperDrive), then press < **Enter** >.

C.4 INSTALL Main Menu

Once you have installed all the questions in the initial INSTALL screen (described in Section 4.2), the main menu shown in Figure C-1 appears.

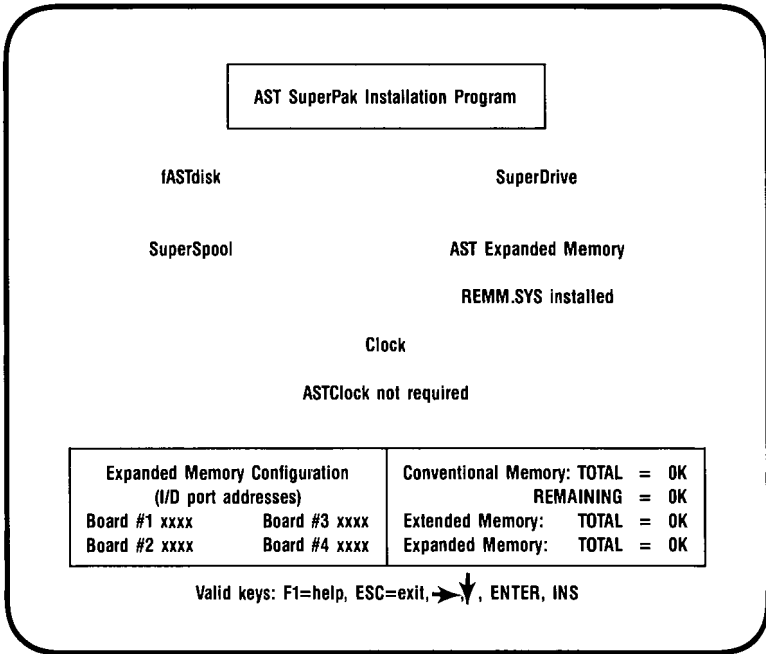

Figure C-1. Main INSTALL Menu.

Notice that the amounts of conventional and expanded memory you set with the PC system board and Rampage switches SW1 and SW2 (or entered if you are preparing a boot disk for another PC) appear at the bottom of the screen. For conventional memory, both the total amount and the remaining amount that has not been allocated are shown.

The amount of extended memory shown refers to expanded memory that *emulates* extended memory.

As you progress, you will notice that as extended memory is allocated, it may be subtracted from expanded memory. This indicates that extended memory is “borrowing” from expanded memory (that is, expanded memory is emulating extended memory).

You can install the programs on the main menu using the keys as described in Section C.1. Detailed step-by-step procedures follow for installing and modifying each SuperPak program.

C.5 Installing fASTdisk

This option allows you to create up to two RAM fixed disk drives (default size: 512 KB each).

To create a fASTdisk:

1. Press the right- or left-arrow key to highlight "fASTdisk".
2. Press <Enter> or <Ins> once for each fASTdisk you want to create. If you press <Enter> more than twice, this message will appear at the bottom of the screen:

Maximum of two fASTdisks allowed

If extended memory is exhausted, the memory totals in the lower right corner of the screen (Figure 4-3) will show 512 KB subtracted from expanded memory, (and added to extended memory) each time you create a fASTdisk. This indicates that fASTdisk is using expanded memory that is emulating extended memory.

To change the size or memory type of a fASTdisk:

1. Press the right- or left-arrow key to highlight "fASTdisk".
2. Press the down-arrow key to highlight the fASTdisk you want to modify (Figure C-2 shows fASTdisk "1" highlighted).
3. Press <Enter> to invoke the edit box, shown in Figure C-2.

6. Press < **Esc** > to exit the edit box. Notice that the memory allocation at the lower right corner of the screen changes to reflect changes you have made.

To delete a fASTdisk:

1. Press the right- or left-arrow key to highlight "fASTdisk".
2. Press the down-arrow key to highlight the fASTdisk you want to delete.
3. Press < **Del** > — the fASTdisk will disappear from the screen.

C.6 Installing SuperDrive

This option allows you to create up to three 360-KB RAM floppy disk drives (depending on PC system board switch settings for the number of floppy drives).

To create a SuperDrive:

1. Press the right- or left-arrow key to highlight "SuperDrive".
2. Press < **Enter** > once for each SuperDrive you want to create.

Watch the memory totals at the lower right corner of the screen (see Figure C-3). 360 KB is subtracted from expanded memory, and added to extended memory, each time you create a SuperDrive.

INSTALL assumes your PC has one floppy diskette drive installed (therefore the first SuperDrive will be B:). If you told INSTALL that your PC has one floppy installed (see the INSTALL initial screen shown in Figure C-1) and you try to create a SuperDrive, this message will be displayed at the bottom of your screen:

Not enough disk devices to add SuperDrive

If, for example, you attempt to create two SuperDrives when you have entered "2" for the total number of floppies and RAM diskettes, this message would be displayed at the bottom of your screen:

Maximum of one SuperDrive allowed

To change the letter designation or memory type of a SuperDrive:

1. Press the right- or left-arrow key to highlight "SuperDrive".
2. Press the down-arrow key to highlight the SuperDrive you want to modify (Figure C-3 shows SuperDrive B: highlighted).
3. Press <Enter> to invoke the edit box shown in Figure C-3.

AST SuperPak Installation Program

Device = B:
Memory type = Extended

SuperDrive
 B: 360K (Extended)
 C: 360K (Extended)

SuperSpool

AST Expanded Memory
REMM.SYS not installed

Clock
 ASTClock not required

Expanded Memory Configuration (I/O port addresses)	
Board #1 xxxx	Board #3 xxxx
Board #2 xxxx	Board #4 xxxx

Conventional Memory: TOTAL = xxxxK
REMAINING = xxxK
Extended Memory: TOTAL = xxxxK
Expanded Memory: TOTAL = xxxxK

Valid keys: F1=help, ESC=exit, →, ↓, ENTER, INS

Figure C-3. INSTALL with SuperDrive Edit Box.

4. Press the up- or down-arrow key to highlight "Device" or "Memory type" (Figure C-3 shows "Device" highlighted).
5. To change the letter designation: Press the right- or left-arrow key to select the letter you want (A:, B:, C:, or D:).

To change the memory type: Press the right- or left-arrow key to select the memory type ("Conventional" or "Extended") you want the SuperDrive to use.

6. Press <Esc> to exit the edit box. Notice that the memory allocation at the lower right corner of the screen now reflects changes you have made.

To delete a SuperDrive:

1. Press the left- or right-arrow key to highlight "SuperDrive".
2. Press the down-arrow key to highlight the SuperDrive you want to delete.
3. Press to delete the SuperDrive.

C.7 Installing the AST Expanded Memory Manager

This option automatically installs REMM.SYS and REX.SYS in your CONFIG.SYS file. REMM.SYS and REX.SYS are the software drivers that make your expanded memory available for expanded memory application programs and for emulation of extended memory. You must install REMM.SYS in order to use expanded memory with application programs, or to use memory beyond 640 KB for RAM disks and spoolers.

NOTE

The expanded memory manager software installed by the INSTALL program is appropriate for most applications. However, software developers who want to edit the REMM and REX command lines in the CONFIG.SYS file can use the parameters described in Appendix E. Make sure you're using the version of REMM.SYS that came with your Rampage board.

To install or delete AST expanded memory software:

1. Press the left- or right-arrow key to highlight "AST Expanded Memory Manager".
2. Press <Enter> to select "REMM.SYS installed" or "REMM.SYS not installed". If you press the down-arrow key, this message will appear at the bottom of the screen:

Device can only be enabled or disabled

C.8 Installing the Clock

This option installs the ASTCLOCK program. ASTCLOCK maintains the time and date even when your PC is off and provides that information to DOS whenever you boot up your PC. You must have AST Clock/Calendar hardware in order to use the ASTCLOCK program, such as the Clock/Calendar on the SixPakPlus board. However, in order to use this version of the ASTCLOCK software, you would have to remove your existing ASTCLOCK software before adding the new ASTCLOCK program supplied with Rampage.

After installing the ASTCLOCK program, you must still initialize ASTCLOCK as described in the manual for the hardware product with a clock, such as the *SixPakPlus User's Manual*.

To install or delete ASTCLOCK software:

1. Press the left- or right-arrow key to highlight "Clock".
2. Press <Enter> to select "ASTClock installed" or "ASTClock not installed". If you press the down-arrow key, this message will appear at the bottom of the screen:

Device can only be enabled or disabled

C.9 Installing SuperSpool

This option allows you to create one RAM print spooler buffer. Whether or not you use INSTALL, your computer can accommodate only one SuperSpool.

You must edit the SUPERSPL command in the AUTOEXEC.BAT file if you are spooling to a serial printer port or you are changing any default parameter (see your *SuperPak User's Manual* for more details).

INSTALL will first attempt to create a SuperSpool buffer from available extended memory, then uses conventional memory. If you create a SuperSpool that is larger than available extended memory, INSTALL will create a buffer from the extended memory that is available. If no extended memory is available, this message is displayed at the bottom of the screen:

Not enough extended memory—switching to conventional

If no extended or conventional memory is available, this message is displayed at the bottom of the screen:

Not enough memory for spooler

The SuperSpool buffer is composed of only one memory type (extended or conventional). INSTALL allocates available expanded memory as extended memory to create a SuperSpool.

NOTE

The term extended memory here refers to expanded memory emulating extended memory.

To create a SuperSpool:

1. Press the left- or right-arrow key to highlight "SuperSpool".
2. Press <**Enter**> to create a SuperSpool.

If you press <**Enter**> again, this message will be displayed at the bottom of the screen:

Maximum of one spooler allowed

To change the device name, size, or memory type of the SuperSpool buffer:

1. Press the left- or right-arrow key to highlight "SuperSpool".
2. Press the down-arrow key to highlight the SuperSpool buffer ("LPT1:" is highlighted in Figure C-4).
3. Press <**Enter**> to invoke the edit box shown in Figure C-4.

6. Press < **Esc** > to exit the edit box. Notice that the memory allocation at the lower right corner of the screen reflects any changes you have just made.

To delete SuperSpool:

1. Press the left- or right-arrow key to highlight "SuperSpool".
2. Press the down-arrow key to highlight "LPTx:".
3. Press < **Del** > to delete the SuperSpool.

C.10 Saving the Installation

1. Press < **Esc** >. This question will appear at the bottom of the screen:

Are you sure you want to quit (y/n)?

Press **Y** to exit **INSTALL**. Press **N** to return to the main **INSTALL** menu.

2. If you press **Y**, this question appears at the bottom of the screen:

Do you want to save configuration (y/n)?

Press **Y** to save the SuperPak software you have just configured using the **INSTALL** program. Pressing **N** exits **INSTALL** without making any changes.

3. If you save the configuration, these messages flash at the bottom of the screen:

Writing CONFIG.SYS to x: . . .

Writing AUTOEXEC.BAT to x: . . .

where x: is the drive containing the boot disk.

4. The screen will then clear and show this message:

For the configuration process to be complete, the following SuperPak utility files need to be present on your boot disk:

The above message is followed by a list of the files necessary to install your SuperPak software, and this question is displayed:

Do you want these files copied to your boot disk (Y/N)?:

5. If you press **Y**, your screen will display this message:

Enter the letter of the disk drive containing your SuperPak software:

Enter the letter of the drive that currently contains your SuperPak software. Your screen will then list the appropriate files as they are copied from the SuperPak diskette to your boot disk.

If there is an error copying SuperPak software to your boot disk, this message will be displayed:

Error copying utility files to drive x:

where x: is the letter of the drive containing the boot disk.

Check that the boot disk is not write-protected, that there is enough room on the boot disk for SuperPak files, that the SuperPak software is in the specified drive, and that the disk drives are closed.

6. If you press **N** (do not copy SuperPak files to the boot disk), or once the SuperPak files have been copied, this message appears on your screen:

Configuration is now complete.

You will need to reboot the system for your updated configuration to take effect.

7. Press **<Ctrl>-<Alt>-** to reboot your PC. If you have installed one fASTdisk, one SuperDrive B:, and one SuperSpool buffer, and you have enabled AST memory manager software, your AUTOEXEC.BAT and CONFIG.SYS files will contain the following lines at the end of the file (assuming you did not change any default parameters):

AUTOEXEC.BAT
superdrv b: /extm
superspl lpt1: /extm

CONFIG.SYS
device = remm.sys /x = B000-BFFF
device = rex.sys 936
device = fastdisk.sys /extm

NOTES

This appendix tells you how to install additional memory on Rampage. You do not need this information unless you are adding to the memory already installed on your Rampage board.

If your Rampage is not fully populated (that is, if less than 2 MB of memory is installed on the board), you can plug in the following combination of Random Access Memory (RAM) chips:

- In the first two banks of memory (banks 0 and 1), you can use either 64-KB RAM chips or 256-KB RAM chips.
- In the last eight memory banks (2-7), you must use only 256-KB RAM chips.

If you wish to replace 64-KB RAM chips with 256-KB RAM chips, or vice versa, you can remove Rampage memory chips simply by prying them loose with a screwdriver, taking care not to damage the chip pins. Guidelines for installing chips are given in Section D.4.

D.1 64-KB RAM Chip Specifications

Use 64-KB RAM chips with these characteristics:

- 50 or 200 nanosecond (ns) access time
- Pin 1 not used
- +5 Volt only

The 64-KB memory chips listed in Table D-1 are compatible with Rampage.

Table D-1. Compatible 64-KB Memory Chips.

MANUFACTURER	PART NUMBER
Fujitsu	MB8264-15P
Hitachi	HM4864P-2
Inmos	IMS2600P-15
Intel	P2164A-15
Micron	Technology MT4264-15
Mitsubishi	M5K4164ANP-15
Mostek	MK4564N-15
Motorola	MCM4164BP15, MCM6665AP15,
NEC	UPD4164C-3
OKI	MSM3764-15RS
Panasonic	MN4164P-15
Samsung	KM4164A-15
Texas Instruments	TMS4164-15NL
Toshiba	TMM4164P-3, TMM4164AP-15

D.2 256-KB RAM Chip Specifications

The 256-KB memory chips listed in Table D-2 are compatible with Rampage.

Table D-2. Compatible 256-KB Memory Chips.

MANUFACTURER	PART NUMBER
AT&T	WCM41256PP-15
Fujitsu	MB81256-15P
Hitachi	HM50256P-15
Hyundai	51C256LS-15
Micron	MT1259-15
Mitsubishi	M5M4256P-15
Motorola	MCM6256AP-15
NEC	UPD41256C-15
OKI	MSM41256A-15RS
SAMSUNG	KM41256-15
Texas Instruments	TMS4256-15NL
Toshiba	TMM41256P-15

After any memory is added or subtracted, the Rampage memory configuration switches must be changed to reflect the new memory configuration (including starting address, conventional on-board memory and RAM configuration). See Section 2 for a full discussion of memory configuration, or Appendix A for a quick reference to the Rampage switch settings.

D.3 Rules for Adding or Removing Memory

The following rules apply when adding memory to or subtracting memory from your Rampage board.

- Each bank must be filled with the same type of memory chip. You cannot mix 64-KB RAM chips and 256-KB RAM chips within one row of memory.
- For each memory size, all specified rows of chips must be populated entirely with 256-KB or 64-KB chips (150 nanosecond (ns) or faster, such as 120 ns, access time).
- You must add or subtract Rampage memory in 64-KB or 256-KB increments — possible memory capacities for the Rampage board are shown in Figures D-1, D-2 and D-3.
- Whenever you add or remove memory, be sure to readjust the SW1 and SW2 Rampage switches if the Rampage memory configuration changes (including the Rampage starting address, RAM configuration, and Rampage conventional on-board memory settings).
- You must run the INSTALL program any time you add or remove memory from the PC. Section 4 describes how to run the INSTALL program.

Figure D-1 shows which memory rows must be populated for each Rampage memory size when 64-KB RAM chips are used in bank 0. Figure D-2 shows which memory rows must be populated for each Rampage memory size when 64-KB RAM chips are used in banks 0 and 1. Figure D-3 shows which memory rows must be populated for each Rampage memory size when 256-KB RAM chips are used in all the memory banks.

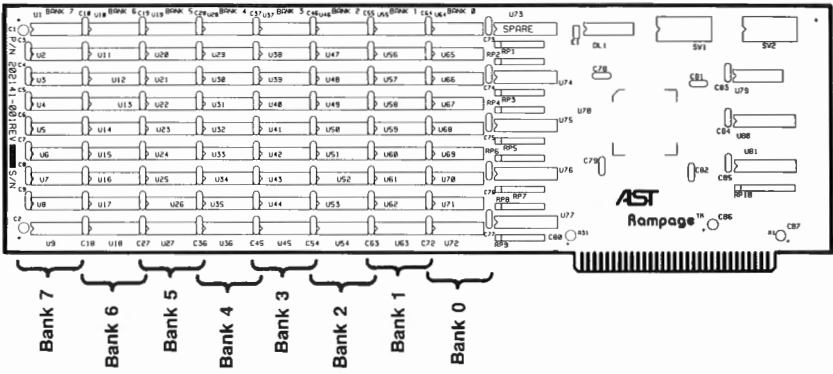

If Rampage memory size is:	These memory banks must be fully populated:
256 KB	0
512 KB	0, 1
768 KB	0, 1, 2
1 MB	0, 1, 2, 3
1.25 MB	0, 1, 2, 3, 4
1.5 MB	0, 1, 2, 3, 4, 5
1.75 MB	0, 1, 2, 3, 4, 5, 6
2 MB	0, 1, 2, 3, 4, 5, 6, 7

Figure D-1. Rampage Memory Banks (all Banks 256-KB).

Adding or Removing Memory

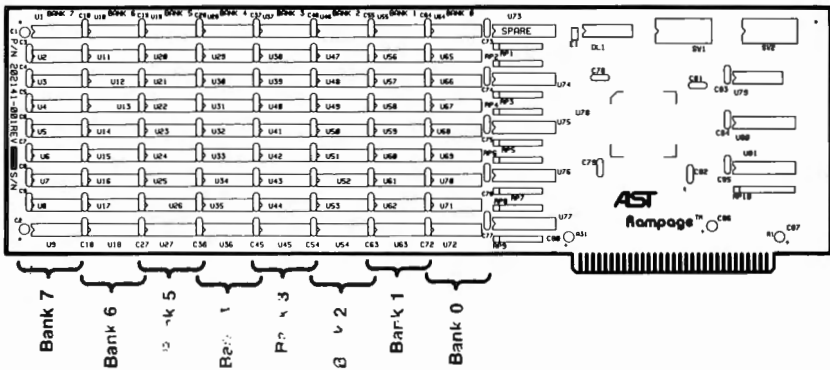

If Rampage memory size is:	These memory banks must be fully populated:
64 KB	0
320 KB	0, 1
576 KB	0, 1, 2
832 KB	0, 1, 2, 3
1088 KB	0, 1, 2, 3, 4
1344 KB	0, 1, 2, 3, 4, 5
1600 KB	0, 1, 2, 3, 4, 5, 6
1856 KB	0, 1, 2, 3, 4, 5, 6, 7

Figure D-2. Rampage Memory Banks (64-KB RAM in one bank).

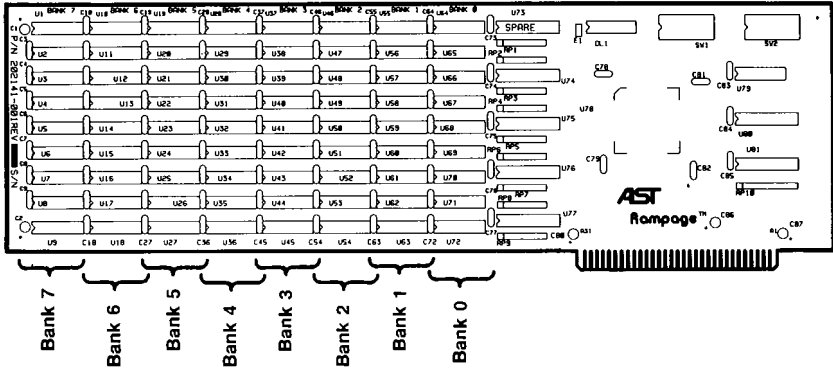

If Rampage memory size is:	These memory banks must be fully populated:
64 KB	0
128 KB	0, 1
384 KB	0, 1, 2
640 KB	0, 1, 2, 3
896 KB	0, 1, 2, 3, 4
1152 KB	0, 1, 2, 3, 4, 5
1408 KB	0, 1, 2, 3, 4, 5, 6
1664 KB	0, 1, 2, 3, 4, 5, 6, 7

Figure D-3. Rampage Memory Banks (64-KB RAM in 2 Banks).

D.4 Guidelines for Installing Chips

Follow these guidelines for installing chips:

- Before handling any chips, discharge any static electricity on your body by touching a grounded surface such as the PC chassis.
- Chips *must* be properly oriented when you install them. The notch on each chip should be facing away from the Rampage bracket.
- If a chip seems to be too wide to fit in its socket, place it on its side on a flat surface and *gently* angle it under both thumbs to *slightly* bend the legs inward. Angle the chip, and slightly insert one row of pins, then bring the other row down into position and slightly start its pins in the socket. Once you have both sides started, you can evenly press down on the chip to seat it firmly in its socket.

This appendix gives a brief overview of how Rampage works, including memory paging and descriptions of AST expanded memory software modules (REMM.SYS and REX.SYS), and how to modify them if necessary. Although you do not need this information to use Rampage, it is provided for those who want some background on how the product functions.

NOTE

Important! To use expanded memory, your boot disk *must* contain REMM.SYS. REX.SYS is also required (along with REMM.SYS) to run RAM disks and print spoolers from expanded memory.

E.1 Memory Paging

By using a technique called *memory paging*, Rampage allows your PC to use *expanded memory* — memory beyond the normal PC memory map.

The IBM PC can address one megabytes (MB) of memory. The normal memory map (shown Figure D-1) allocates the first 640 kilobytes (KB) of PC memory as user memory. Some of the PC memory between 640 KB and 1 MB is used for such purposes as video RAM and ROM to support PC housekeeping functions —but there are large unused areas.

Each Rampage board can contain up to 2 MB of physical memory. Rampage physical memory is divided into 16-KB blocks called *pages*. Rampage software (along with your expanded memory application software) swaps memory pages in and out of open *windows* in the area between 640 KB and 1 MB. To further enhance performance, the AST expanded memory manager can also take advantage of Rampage

How Rampage Works

memory *below* 640 KB. This process — memory paging — allows your PC to access up to 2 MB of Rampage physical memory at RAM speeds, completely transparent to the user.

You can allocate any portion of Rampage memory as conventional memory (from 64 to 640 KB). Whatever Rampage memory is left will be used by the REMM software (if installed) as paged memory.

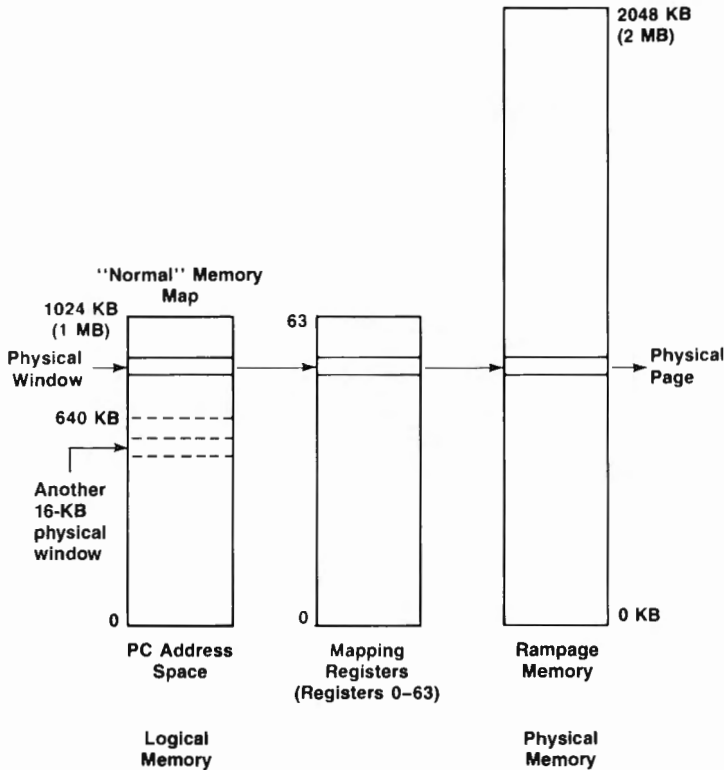

Figure E-1. Paging Technique.

E.2 Expanded Memory Manager — REMM.SYS

The REMM software driver swaps memory between the Rampage board and PC memory by creating pointers, loading the registers, and mapping PC windows to Rampage expanded memory. REMM also conducts an integrity test on the expanded memory when the PC is turned on. This prevents any Rampage memory that is not working properly from being used.

Your application program must keep track of what page of Rampage memory holds a particular element of data, in order to retrieve it. According to parameters supplied by the application program, REMM links windows in logical PC memory to pages of Rampage physical memory by means of the 64 mapping registers, the Map Control register and the Page registers.

REMM also allocates Rampage memory to several *Process IDs* (also known as *expanded memory manager (EMM) handles*). Each Process ID is allocated to a particular application program, and has certain pages of memory allocated to it. Process IDs aid in multitasking.

Before memory mapping is enabled, REMM automatically maps any of the 16-KB pages that are to fill out the 640 KB on the PC. You can circumvent this automatic allocation by setting Rampage switches to indicate that the starting memory address is 640 KB. Using the INSTALL program to select the AST memory manager installs REMM.SYS and automatically configures it for your system.

E.3 Extended Memory Emulator — REX.SYS

REX interfaces with the REMM program to make Rampage expanded memory act like PC-AT extended memory. This allows you to use AST's fASTdisk, SuperDrive, and SuperSpool (also IBM's DOS 3.x VDISK.SYS utility with the "/E" option) to create RAM disks or a print spooler in Rampage expanded memory.

REX intercepts calls on read-only memory basic input/output system (ROM BIOS) functions designed for extended memory use, and interfaces them to the REMM software so that they can use Rampage expanded memory.

REX must be installed after the REMM software, and it cannot function without REMM software. REX must be installed if you plan to operate SuperDrive or SuperSpool from extended memory, or if you want to use the VDISK.SYS "/E" option (which uses extended memory). The SuperPak INSTALL program automatically installs REX (if needed) configured for your system.

As with applications that use the REMM software, program code portions of the SuperPak programs must reside in the 640 KB of PC memory. However, data associated with SuperPak utilities can use Rampage expanded memory.

E.4 Modifying REMM and REX

As installed with AST's SuperPak INSTALL program, REMM and REX should not require further modification. However, the information in this section is provided as a reference.

You can add these statements to your CONFIG.SYS file to change the default REMM and REX software drivers:

```
DEVICE = REMM.SYS [/X] [/P] [/S] [/D] [/C] [/N]
```

and/or

```
DEVICE = REX.SYS [nnnn]
```

This section describes the parameters you can use with each of these statements.

E.4.1 DEVICE = REMM.SYS Parameters

You can append multiple parameters to the DEVICE = REMM statement. Separate parameters with one blank space. This section describes the following REMM parameters:

```
DEVICE = REMM.SYS [/X] [/P] [/S] [/D] [/C] [/N]
```

With the exception of the “/X” parameter, the following are intended for software developer use.

/X = — Exclude

The /X parameter allows you to exclude certain ranges of memory from REMM mapping. REMM will never map into memory space that is already occupied, but you may have an application for which you would like to reserve certain memory ranges.

NOTE

If you will be using software designed for the enhanced expanded memory specification (EEMS), AST recommends excluding the area used by video memory from mapping.

The INSTALL program automatically installs the appropriate “/X” parameter. (INSTALL excludes the 0B000-0BFFFh range for an IBM monochrome adapter, Hercules graphics adapter, or compatible; 0B800-0BFFFh for an IBM color graphics adapter or compatible; 0A000-0BFFFh for an IBM enhanced graphics adapter or compatible, or for other types of video cards.)

Format: **/X = nnnn-nnnn**

where *n* is a hexadecimal digit. The first *nnnn* is the starting address of the range, and the second *nnnn* is the ending address.

You can specify multiple ranges as long as you separate each address range with one blank.

Default: None excluded.

Example: **DEVICE = REMM.SYS /X = B000-BFFF**

This is the standard statement for a system that includes a Hercules graphics adapter.

Example: **DEVICE = REMM.SYS /X = C140-CA00 /X = DDDD-DDFF**

Notes: You must leave at least one contiguous 64-KB segment of memory available for mapping by REMM starting in the range C000 through E000. In other words, you may not use the /X parameter to exclude all contiguous 64-KB segments that start in that range.

/PIDS = or /P = — Process IDs

The /P parameter limits the number of Process IDs that REMM will allow. A *Process ID* is the identification assigned to each user or application on the system.

Format: **/PIDS = n or /P = n (short form)**

where *n* is a decimal number from 2 to 256.

Default: The default value is 32.

Example: **DEVICE = REMM.SYS /PIDS = 12**

Notes: Increasing the number of Process IDs increases the amount of memory used by REMM.

/START = or /S = — Start

The /S parameter tells REMM to put logical page 0 of the mapping window at the specified segment address. This hexadecimal address must be on a 16-KB boundary, and must be within the 0C000-0E000h range.

Format: **/START = nnnn**

where *n* is a hexadecimal digit.

Default: Determined dynamically by REMM.

Example: **DEVICE = REMM.SYS /START = C000**

/DEPTH = or /D = — Depth

The /D parameter specifies the maximum number of mapping register contexts per Process ID that REMM can save. Unless you are developing software, the default value should be adequate.

Format: **/DEPTH = nn**

where *nn* is any decimal number from 1 to 32.

Default: The default value is 5.

Example: **DEVICE = REMM.SYS /DEPTH = 15**

/CONTEXTS = or /C = — Total Contexts

The /C parameter specifies the total number of mapping register contexts that can be saved for all Process IDs combined. Unless you are developing software, the default value should be adequate.

Format: **/CONTEXTS = nnn**

where *n* is a decimal digit.

Default: The value of DEPTH plus the value of PIDS minus one.

Example: **DEVICE = REMM.SYS /CONTEXTS = 36**

Notes: The value of CONTEXTS cannot be less than the value of PIDS.

/N — Nomenclature

The /N parameter causes an informational message similar to the following to be displayed at bootup:

Rampage Expanded Memory Manager	Version X.xx
© Copyright AST Research, Inc. 1985, 1986	All Rights Reserved
KB ok	Board at Port
1152	0268
1024	0256
Expanded Memory Pages:	136
Windows START at:	C000h
Process IDs:	32
Contexts:	36
Depth:	5
Mode:	1F

E.4.2 DEVICE = REX.SYS Parameters

The AST SuperPak INSTALL program automatically configures and installs the appropriate command statement for REX.

Format: **DEVICE = REX.SYS [nnnn]**

where *nnnn* is a decimal number indicating the amount of memory (in KB) allocated for use by REX.

Default: The default value is 512 (KB).

Example **DEVICE = REX.SYS 1024**

Notes: The amount of memory allocated to REX must be at least as much as the sum of all extended memory used by fASTdisk, SuperDrive, SuperSpool, IBM's VDISK, and any other RAM disks and print spoolers set up to use memory outside the 0- to 640-KB area. If you do not express this value as a multiple of 16 KB, it will automatically be rounded up to the next highest multiple.

E.4.3 Modifying CONFIG.SYS for fASTdisk

If you intend to use fASTdisk for virtual disk software, be sure to add the appropriate statement to your CONFIG.SYS file as described in your IBM *SuperPak User's Manual*. The `DEVICE = FASTDISK.SYS` statement must follow the `REMM` and `REX` statements in the CONFIG.SYS file to enable fASTdisk to use Rampage memory.

NOTES



This appendix includes a list of error messages that are generated by RAMpage software when certain problems may occur, and a Product Repair Procedure to follow in the unlikely event a repair is needed.

F.1 Error Messages

Although your *RAMpage* board is designed for easy installation and reliable operation, problems can sometimes occur. This appendix includes a list of some error messages that may be displayed if problems are encountered while the RAMpage Expanded Memory Manager (REMM) or the RAMpage EXTended Memory Emulator (REX) are initializing. Each list is in alphabetical order.

An explanation is given for each message. When appropriate, an action is suggested to remedy the problem. Only messages generated by *RAMpage* software are listed here. Other error messages may be generated by the PC Disk Operating System, and are documented in your *PC-DOS Reference Manual*.

F.1.1 REMM Initialization Error Messages

RAMpage: **Illegal or conflicting switch settings.**

Explanation: There is more than one RAMpage board installed, and two or more have a starting address below 640 KB (indicated by switches SW2-1 to SW2-4). REMM cannot function if more than one RAMpage board has a starting address below 640 KB.

Action: Change the starting address on one or more RAMpage boards so that not more than one is below 640 KB.

RAMpage:

No logical memory pages found.

Explanation: This message indicates either that REMM cannot find any RAMpage boards or that there is no memory available for use in mapping. All memory on the RAMpage board may be in use filling out the 640 KB of system memory for the PC.

Action: Delete the line **DEVICE = REMM.SYS** from the CONFIG.SYS file if all RAMpage is being used to fill out 640 KB of system memory.

RAMpage:

No valid Page Frame Base Address found.

Explanation: REMM cannot find a free 64-kilobyte (KB) block of memory between 640 KB and 1 Megabyte (MB) in PC memory, which is needed for memory paging to occur. This may occur because the **/X =** parameter in the DEVICE statement installing REMM in the CONFIG.SYS file (described in Appendix B) has excluded too many blocks of memory in this region from use, or because other software modules are installed in the 640-KB to 1 MB region.

Action: Check the CONFIG.SYS file, and remove any **/X** parameters that exclude memory segments needed for completing a 64-KB area between 640 KB and 1 MB.

RAMpage:

Unavailable Page Frame Base Address specified in /START = parameter.

Explanation: The **/START =** parameter in the DEVICE statement that installs REMM in the CONFIG.SYS file specifies a segment address that is NOT the start of an available block of 64 KB of memory in the range from 640 KB to 1 MB.

Action: No action is necessary. REMM will choose its own PFBA (if a valid one exists) after displaying this message and will continue with initialization.

F.1.2 REX Initialization Error Messages

Expanded Memory Manager is not present

Explanation: This message indicates that REX has failed to detect REMM, which is necessary for REX to function. If this message appears, REX will not function.

Action: Make sure the CONFIG.SYS file has the line **DEVICE = REX.SYS** after the **DEVICE = REMM.SYS** command, and that the file REMM.SYS is in the root directory of the diskette used to initialize the PC.

Extended Memory allocation adjusted

Explanation: The **DEVICE = REX.SYS** command in the CONFIG.SYS file requested more memory to be used as extended memory than the total available expanded memory. In this situation, REX actually allocates as much expanded memory as is available.

Action: No action is necessary. While it is initializing, REX issues a message indicating how much memory is actually reserved for use with REX.

Non-recoverable error in Expanded Memory Manager

Explanation: This message indicates that REMM is present but has returned a non-recoverable error code to REX. If this message appears, REX will not function.

Action: Check which error message was issued for REMM and the suggested action in this Section.

F.2 Product Repair Procedure

If your AST Research product ever requires repair, contact your dealer first. The dealer from whom you originally purchased the product can usually service the product. If you must return a hardware product to the factory for service, follow these guidelines to ensure rapid, accurate turnaround:

1. *Call AST Research Technical Support for a Return Authorization Number (RAN):* A technician will discuss the problem with you. Please supply the technician with model and serial numbers for your AST product. If factory service is required, the technician will give you a Return Authorization Number (RAN). Always refer to the RAN when you return anything for service. AST Research will return anything without a RAN to the sender.
2. *If the product is covered under an AST Research Warranty:* There is no charge for parts or labor involved in the repair. Please include a copy of your original purchase receipt as the proof of date of purchase for all warranty repairs.
3. *If the product is not covered under a warranty:* Contact your dealer or AST Research Technical Support for instructions on obtaining service for your product.
4. *Parts not covered under the warranty:* Dealer- or user-installed parts (such as RAM chips) are not covered under the terms of the warranty. Dealer-installed parts are warranted by the dealer; parts that you install are covered only by the parts suppliers' warranties. If we find that your dealer- or user-installed parts are defective, we can identify which parts are defective, but we will not replace parts unless you specifically authorize us to do so in writing when you send the board to us. The parts charges and any applicable labor charges will be billed COD.

5. *Describe the problem and return any related accessories:* Please include a brief but explicit written description of the problem when you return your AST product to the factory for repair. Also return any accessories that might relate to the problem. For example, if the the parallel port does not function correctly, be sure to return the parallel port adapter cable with the board.

6. *Be sure to provide a return shipping address that UPS can deliver to and include your RAN:* UPS cannot normally deliver to post office boxes. Reference the RAN issued to you by AST Technical Support on all correspondence. Securely package all materials to prevent shipping damage. Shipping charges must be prepaid; CODs will not be accepted. Ship the materials to the following address:

AST Research, Inc.
Customer Service – RAN xxxx
2722 Michelson
Irvine, CA 92715

where xxxx is your assigned Return
Authorization Number.

7. Once your product is repaired, we will return it to you by UPS or UPS Blue Label service, whichever is appropriate for your geographical location. We will return items covered by warranty at our expense. Shipping costs and repair expenses for items not covered by warranty will be billed COD. If you prefer overnight service (UPS Red Label), the shipping charges will be billed COD. If you want us to ship Federal Express, please give us your Federal Express account number for billing purposes.

NOTES

GLOSSARY

Following are definitions of some technical terms used in this manual:

AUTOEXEC.BAT file

A batch file of Disk Operating System (DOS) commands with the file name AUTOEXEC.BAT that your PC automatically executes when you boot or reboot the computer. The commands in this file are used to install software each time your PC boots up.

For example, if you want to create a SuperDrive random access memory (RAM) disk whenever you are using your PC, you would place the command that creates the SuperDrive in your AUTOEXEC.BAT file. You can use the SuperPak INSTALL program described in Section 4 to create an AUTOEXEC.BAT file to initiate the SuperPak utilities you select.

CONFIG.SYS file

A file of commands used to configure your computer system and install software device drivers. Device drivers are programs that allow your PC to communicate with hardware devices such as the Rampage board. The commands in the CONFIG.SYS file are executed automatically when you boot or reboot your PC, before the AUTOEXEC.BAT file commands.

For example, if you want to use part or all of your Rampage memory as expanded memory, you must place a command in your CONFIG.SYS file to install the Rampage Expanded Memory Manager (REMM) device driver. You can use the SuperPak INSTALL program described in Section 4 to create a CONFIG.SYS file that automatically installs the device drivers needed to use Rampage memory as expanded.

Conventional memory

Memory used to fill up PC system memory, up to the maximum of 640 kilobytes (KB) recognized by the DOS.

DESQview

A multitasking/windowing software product that allows you to run several programs concurrently and view them through several windows on your PC display screen.

Device driver

A program that allows your PC to use hardware in your PC system. The REMM and Rampage Extended Memory Emulator (REX) are both device driver programs that allow your PC to use Rampage memory as expanded memory.

Expanded memory

Also called paged memory. Expanded memory is memory provided on the Rampage board that is not allocated as part of PC conventional memory. Rather, it is swapped in and out of windows in the PC address space that DOS can recognize, using special software device drivers provided with your Rampage. Expanded memory provides maximum performance with new multitasking/windowing software, including DESQview.

Extended memory

Memory at addresses of one megabyte (MB) or greater on the PC-AT. Extended memory is also referred to as *protected mode* extended memory (protected mode is explained in the *PC-AT Technical Reference Manual*). Rampage expanded memory can simulate extended memory with the use of Rampage Extended Memory Emulator (REX) software. This extended-paged memory is not actually protected mode memory in the 1-16 MB address range. However, programs designed to use extended memory can use extended-paged memory as well.

Kilobyte (KB)

A unit of measure for memory. KB is an abbreviation for kilobyte. One KB is equal to 1024 bytes of memory.

Megabyte (MB)

A unit of measure for memory. MB is an abbreviation for megabyte. One MB is equal to one thousand kilobytes, and approximately one million bytes, of memory.

Paged memory

Also called expanded memory. Expanded memory is memory provided on the Rampage board that is not allocated as part of PC conventional memory. Rather, it is swapped in and out of windows in the PC address space that DOS can recognize, using special software device drivers provided with your Rampage. Expanded memory provides maximum performance with new multitasking/windowing software, including Lotus 1-2-3 release 2 and DESQview.

Rampage Expanded Memory Manager (REMM)

REMM is a device driver program that enables your PC to use Rampage expanded memory with application programs.

Rampage Extended Memory Emulator (REX)

REX is a device driver program that enables your PC to use *Rampage!* expanded memory with applications that are designed for PC-AT protected mode extended memory.

VDISK

An IBM software product that allows you to create simulated hard disks in random access memory (RAM).

NOTES

AST RESEARCH, INC.

Product Comment Form

**Rampage®
User's Manual
000412-001 B**

We appreciate your comments regarding any problems or suggestions related to AST Research products. Please use this form to communicate any observations that you have concerning the improvement of either the product itself or the product documentation provided in this manual.

Submitter Information

Submitter's name:

Address:

Product/Manual Comments and Suggestions

Please mail this form to:

AST Research, Inc.
Attn: Product Marketing
2121 Alton Ave.
Irvine, CA 92714

(

(

(

LIMITED WARRANTY

AST Research, Inc. warrants to the original purchaser of this AST Research, Inc. product that it is to be in good working order for a period of 2 years from the date of purchase from AST Research, Inc. or an authorized AST Research, Inc. dealer. Should this product, in AST Research, Inc.'s opinion, malfunction during the warranty period, AST will, at its option, repair or replace it at no charge, provided that the product has not been subjected to misuse, abuse, or non-AST authorized alterations, modifications, and/or repairs.

Products requiring Limited Warranty service during the warranty period should be delivered to AST with proof of purchase. If the delivery is by mail, you agree to insure the product or assume risk of loss or damage in transit. You also agree to prepay shipping charges to AST.

ALL EXPRESS AND IMPLIED WARRANTIES FOR THIS PRODUCT INCLUDING, BUT NOT LIMITED TO, THE WARRANTIES OF MERCHANTABILITY AND FITNESS FOR A PARTICULAR PURPOSE ARE LIMITED IN DURATION TO THE ABOVE 2 YEAR PERIOD. Some states do not allow limitations on how long an implied warranty lasts, so the above limitations may not apply to you.

UNDER NO CIRCUMSTANCES WILL AST RESEARCH, INC. BE LIABLE IN ANY WAY TO THE USER FOR DAMAGES, INCLUDING ANY LOST PROFITS, LOST SAVINGS OR OTHER INCIDENTAL OR CONSEQUENTIAL DAMAGES ARISING OUT OF THE USE OF, OR INABILITY TO USE, SUCH PRODUCT. Some states do not allow the exclusion or limitation of incidental or consequential damages for consumer products, so the above limitations or exclusion may not apply to you.

THIS WARRANTY GIVES YOU SPECIFIC LEGAL RIGHTS, AND YOU MAY ALSO HAVE OTHER RIGHTS WHICH MAY VARY FROM STATE TO STATE.

The limited warranty applies to hardware products only.

(

(

(

000412-001 B